



—
your partner
in sensor
technology.

+ User Manual HTS801

**Humidity and Temperature Sensor for
High Humidity and Chemically
Polluted Conditions**



Content

1	General Information	4
1.1	Explanation of Warning Notices and Symbols	4
1.2	Safety Instructions	5
1.2.1.	General Safety Instructions	5
1.2.2.	Alarm Module with Voltages >50V (Option AM2)	5
1.2.3.	Integrated power supply 100 - 240 V AC (Option AM3)	5
1.2.4.	Intended Use	5
1.2.5.	Mounting, Start-up and Operation	6
1.3	Environmental Aspects	7
1.4	ESD Protection	7
2	Scope of Supply	7
3	Product Description	8
3.1	General	8
3.2	Product Design	8
3.3	Configuration Interface	9
3.4	Operation and Heating Modes	10
3.4.1.	Overview Operation Modes and Types	10
3.4.2.	Automatic ReCover (ARC) against Chemical Pollution	10
3.4.3.	Condensation Guard (CG) against Temporary Condensation	12
3.4.4.	High Humidity Guard (H ² G) against Continuous High Humidity and Condensing Conditions	13
3.5	Optional Features	13
3.5.1.	TFT Colour Display	13
3.5.2.	rapidX Smart Probe (Option PC7)	15
3.5.3.	ARC Module (Option AM1)	16
3.5.4.	Alarm Module (Option AM2)	17
3.5.5.	Integrated Power Supply 100 - 240 V AC (Option AM3)	19
3.5.6.	RS485 Module - Modbus RTU (Option J3)	20
3.5.7.	Ethernet Module - Modbus TCP (Option J4)	20
3.5.8.	Retrofit with Ethernet module	22
3.6	Dimensions	22
4	Mounting and Installation	23
4.1	Sensor Enclosure	23
4.2	General Information for Mounting HTS801 Sensing Probes	24
4.3	Remote Sensing Probe Type T5	25
4.4	Remote Sensing Probe Type T7	25
4.4.1.	Installation at normal pressure	25
4.4.2.	Pressure-tight Installation	26
4.5	Remote Sensing Probe Type T9	27
4.6	Remote Sensing Probe Type T10	29
4.6.1.	Installation of the Probe directly in the Process	29
4.6.2.	Installation of the Probe with Ball Valve Set	30
4.7	Remote Sensing Probes Type T17	31
4.7.1.	Installation at Normal Pressure	31
4.7.2.	Pressure-tight Installation	32
4.8	Remote Sensing Probes Type T28	32
5	Electrical Connection	32
5.1	Electrical Connection and Wiring Overview	33
5.2	With Cable Glands	36
5.3	Plug Options	36
5.4	ARC Module (Option AM1)	36
5.5	Alarm Module (Option AM2)	36
5.6	Integrated Power Supply 100 - 240 V AC (Option AM3)	37

6	Setup and Configuration	38
6.1	PCS10 Product Configuration Software	38
6.1.1.	General	38
6.1.2.	Analogue Outputs.....	38
6.1.3.	Simulation Mode.....	39
6.1.4.	Multipoint Adjustment	39
6.1.5.	Eventlog and Histograms.....	39
6.2	RS485 Digital Interface	39
6.2.1.	Modbus RTU Setup	39
6.2.2.	Modbus Register Map	41
6.2.3.	Freely Configurable Custom Modbus Map.....	42
6.2.4.	Device Status Indication	43
6.2.5.	Module Status Indication	44
6.2.6.	Device Operating Conditions Indication.....	44
6.2.7.	Retrofit with RS485 Module.....	45
6.3	Modbus RTU Example	45
7	Maintenance and Service	46
7.1	Self Diagnosis and Error Messages	46
7.1.1.	Error Messages on the Display.....	46
7.1.2.	Status and Error Messages via LEDs	46
7.2	Cleaning the Sensing Head and Filter Cap Replacement.....	47
7.3	Automatic ReCovery (ARC)	47
7.4	RH and T Calibration and Adjustment	47
7.4.1.	RH and T Adjustment and Calibration for Types T5 / T9 / T10	49
7.4.2.	RH and T Adjustment and Calibration for Type T7	49
7.4.3.	RH and T Adjustment and Calibration for Types T17 / T28.....	49
7.5	Fuse Replacement for Integrated Power Supply 100 - 240 V AC (Option AM3)	50
8	Spare Parts / Accessories	50
9	Technical Data	51
10	Conformity	54
10.1	Declarations of Conformity.....	54
10.2	FCC Part 15 Compliance Statement	54
10.3	ICES-003 Compliance Statement.....	54
11	Appendix: Display Menu Structure	55
11.1	Overview.....	55
11.2	Detailed Information.....	55
11.3	Optional Menus.....	59

1 General Information

This user manual serves for ensuring proper handling and optimal functioning of the device. The user manual shall be read before commissioning the equipment and it shall be provided to all staff involved in transport, installation, operation, maintenance and repair. E+E Elektronik Ges.m.b.H. does not accept warranty and liability claims neither upon this publication nor in case of improper treatment of the described products.

All information, technical data and diagrams included in this document are based on the information available at the time of writing. It may contain technical inaccuracies and typographical errors. The contents will be revised on a regular basis and changes will be implemented in subsequent versions. The described product(s) and the contents of this document may be changed or improved at any time without prior notice.

All rights reserved by E+E Elektronik Ges.m.b.H. No part of this document may be reproduced, published or publicly displayed in any form or by any means, nor may its contents be modified, translated, adapted, sold or disclosed to a third party without prior written permission of E+E Elektronik Ges.m.b.H.

PLEASE NOTE

Find this document and further product information on our website at www.epluse.com/hts801.

1.1 Explanation of Warning Notices and Symbols

Safety precautions

Precautionary statements warn of hazards in handling the device and provide information on their prevention. The safety instruction labeling is classified by hazard severity and is divided into the following groups:

DANGER

Danger indicates hazards for persons. If the safety instruction marked in this way is not followed, the hazard will very likely result in severe injury or death.

WARNING

Warning indicates hazards for persons. If the safety instruction marked in this way is not followed, there is a risk of injury or death.

CAUTION

Caution indicates hazards for persons. If the safety instruction marked in this way is not followed, minor or moderate injuries may occur.

NOTICE

Notice signals danger to objects or data. If the notice is not observed, damage to property or data may occur.

Informational notes

Informational notes provide important information which stands out due to its relevance.

INFO

The information symbol indicates tips on handling the device or provides additional information on it. The information is useful for reaching optimal performance of the device.

The title field can deviate from "INFO" depending on the context. For instance, it may also read "PLEASE NOTE".

1.2 Safety Instructions

1.2.1. General Safety Instructions

NOTICE

Improper handling of the device may result in its damage.

- The HTS801 enclosure, the sensing probe and the sensing module shall not be exposed to unnecessary mechanical stress.
- Do not apply the supply voltage to the RS485 data lines.
- The HTS801 electronics is sensitive to electrostatic discharge (ESD), appropriate protective measures shall be taken when touching it.
- When replacing the filter cap make sure not to touch the sensing elements.
- The device must be operated with the filter cap on at all times.
- For sensor cleaning and filter cap replacement please see “Cleaning Instructions” at www.epluse.com.
- Installation, electrical connection, maintenance and commissioning shall be performed by qualified personnel only.
- The devices are designed for the operation with class III supply (EU) and class 2 supply (NA).
- The power supply must be switched off before opening the housing.
- Use the HTS801 only as intended and observe all technical specifications.
- An existing Ethernet connection must be disconnected before opening the enclosure.

1.2.2. Alarm Module with Voltages >50V (Option AM2)

WARNING

Notice signals danger to objects or data. If the avoidance instructions are not observed, damage to property or data may occur.

- The optional alarm module is isolated from the low-voltage side of the HTS801 by a special partition; this must remain fitted at all times in the base module of the enclosure.
- The HTS801 enclosure must be tightly closed during operation. An open enclosure corresponds to IP00 and exposes components carrying dangerous voltage. Any work (maintenance for instance) on the device may be performed by qualified staff only.

1.2.3. Integrated power supply 100 - 240 V AC (Option AM3)

WARNING

Notice signals danger to objects or data. If the avoidance instructions are not observed, damage to property or data may occur.

- The HTS801 enclosure must be tightly closed during operation. An open enclosure corresponds to IP00 and exposes components carrying dangerous voltage. Any work (maintenance for instance) on the device may be performed by qualified staff only.

1.2.4. Intended Use

The HTS801 sensors are designed to meet the highest demands of stable and highly accurate measurements of relative humidity (RH) and temperature (T) under the most challenging conditions. The RH and T sensor handles a wide range of applications from -80 °C (-112 °F) up to 180°C (356 °F) and 300 bar (4 350 psi), even under harsh environmental conditions such as constant high humidity and chemical contamination.

With different intelligent operating modes, HTS801 can be perfectly tailored to the specific needs of each measurement task. Depending on the type and duration of the exposure (humidity, chemicals), the monolithic RH and T sensing element is exposed to an appropriate heating strategy.

The use of the HTS801 in any other way than described in this manual bears a safety risk for people and the entire measurement installation and is therefore not allowed.

The manufacturer cannot be held responsible for damages as a result of incorrect handling, installation, and maintenance of the equipment.

The device may only be powered as described in this manual.

In order to avoid damage to the instrument or health hazards, the measuring equipment must never be manipulated with tools that are not specifically described in this manual. The sensor may only be utilized in accordance with the conditions defined in the technical data. Otherwise, measurement inaccuracies will occur and equipment failures cannot be ruled out. The steps recommended by the manufacturer for installation, inspections and maintenance work must be observed and carried out for the safety of the user and for the functionality of the equipment.

WARNING

Non-compliance with the product documentation may cause safety risk for people and the entire measurement installation.

The manufacturer cannot be held responsible for damages as a result of incorrect handling, installation and maintenance of the device.

- Do not use HTS801 in explosive atmosphere or for measurement of aggressive gases.
- This device is not appropriate for safety, emergency stop or other critical applications where device malfunction or failure could cause injury to human beings.
- The device may not be manipulated with tools other than specifically described in this manual.

NOTICE

Failing to follow the instructions in this user manual may lead to measurement inaccuracy and device failures.

- The HTS801 may only be operated under the conditions described in this user manual and within the specification included in chapter 9 Technical Data.
- Unauthorized product modification leads to loss of all warranty claims. Modification may be accomplished only with an explicit permission of E+E Elektronik Ges.m.b.H.!

1.2.5. Mounting, Start-up and Operation

The HTS801 humidity and temperature sensor has been produced under state of the art manufacturing conditions, has been thoroughly tested and has left the factory after fulfilling all safety criteria. The manufacturer has taken all precautions to ensure safe operation of the device. The user must ensure that the device is set up and installed in a way that does not impair its safe use. The user is responsible for observing all applicable local and international safety guidelines for safe installation and operation of the device. This user manual contains information and warnings that must be observed by the user in order to ensure safe operation.

PLEASE NOTE

The manufacturer or his authorized agent can be only be held liable in case of willful or gross negligence. In any case, the scope of liability is limited to the corresponding amount of the order issued to the manufacturer. The manufacturer assumes no liability for damages incurred due to failure to comply with the applicable regulations, operating instructions or the specified operating conditions. Consequential damages are excluded from the liability.

⚠ WARNING

Non-compliance with the product documentation may cause accidents, personal injury or property damage.

- Mounting, installation, commissioning, start-up, operation and maintenance of the device may be performed by qualified staff only. Such staff must be authorized by the operator of the facility to carry out the mentioned activities.
- The qualified staff must have read and understood this user manual and must follow the instructions contained within.
- All process and electrical connections shall be thoroughly checked by authorized staff before putting the device into operation.
- Do not install or start-up a device supposed to be faulty. Make sure that such devices are not accidentally used by marking them clearly as faulty.
- A faulty device may only be investigated and possibly repaired by qualified, trained and authorized staff. If the fault cannot be fixed, the device shall be removed from the process.
- Service operations other than described in this user manual may only be performed by the manufacturer.

1.3 Environmental Aspects

i PLEASE NOTE

Products from E+E Elektronik Ges.m.b.H. are developed and manufactured in compliance with all relevant environmental protection requirements. Please observe local regulations for the disposal of the device.



For disposal, the individual components of the device must be separated according to local recycling regulations. The electronics shall be disposed of correctly as electronics waste.

1.4 ESD Protection



The sensing elements and the electronics board are ESD (electrostatic discharge) sensitive components of the device and must be handled as such. Failure to do so may damage the device by electrostatic discharge when touching exposed sensitive components.

2 Scope of Supply

	Included in all versions	With option
HTS801 according to ordering guide	✓	
Manual HTS801	✓	
Inspection certificate according to DIN EN 10204-3.1	✓	
Mating plug for integrated power supply		AM3
Mating plug RKC 5/7		AM3 / E4 / E6
Mating plug RSC 5/7		E6
Mating plug HPP V4 RJ45 Cat5		J4
M16 cable gland		Except for Options E4 / E6 / AM3
Cut-in fitting		HTS801-M1T9

3 Product Description

3.1 General

The HTS801 is available with 6 remote probe types according to the applications RH/T/p range and environmental condition like high humidity and chemical pollution. It offers various probe and cable lengths (for the dimensions, please refer to chapter 3.6 Dimensions)

Probe Type	Description
T5	Remote probe up to 180 °C (356 °F)
T7	Remote probe for cut-in fitting, pressure-tight up to 20 bar (300 psi) and 180 °C (356 °F), with optional cut in fitting, for dew point (Td) measurement
T9	Remote probe, pressure-tight up to 300 bar (4 350 psi) and 180 °C (356 °F), with cut-in fitting
T10	Remote probe, pressure-tight up to 20 bar (300 psi) and 180 °C (356 °F), with sliding fitting
T17	Two remote probes, pressure-tight up to 20 bar (300 psi) and 180°C (356 °F), with optional cut-in fitting
T28	Two remote probes, for meteorological applications

The employed high-end E+E RH and T sensing element is heated autonomously and enables reliable and long-term stable measurements in extremely humid or chemically polluted environments. The monolithic structure of the RH/T sensing element ensures a fast return to normal conditions after condensation or chemical contamination. In addition, it is perfectly protected by the E+E proprietary coating.

Different heating modes of the monolithic RH and T sensing element allow for best adaption to the specific needs of each measuring task. Furthermore, types T7, T17 and T28 offer a dual heating system (probe body and sensing element are heated) to prevent condensation on the RH sensing element and on the probe body for continuous high humidity operation.

The measured data is available on two freely scalable analogue outputs, on the RS485 (Modbus RTU) or Ethernet-PoE (Modbus TCP) interface and on the alarm (relay) outputs. The configuration and the RH and T adjustment of the HTS801 can be performed with the free PCS10 Product Configuration Software. An optional 3.5" colour display with push-buttons is available for configuration and visualisation.

The HTS801 with PC7 option (see ordering guide) features the intelligent pluggable rapidX probe, which enables a plug-and-play probe exchange.

The optional Automatic ReCovery (ARC) module allows for external triggering of the heating functionality.

With integrated power supply option the HTS801 can powered with 100 - 240 V AC (50/60 Hz), 2 VA.

3.2 Product Design

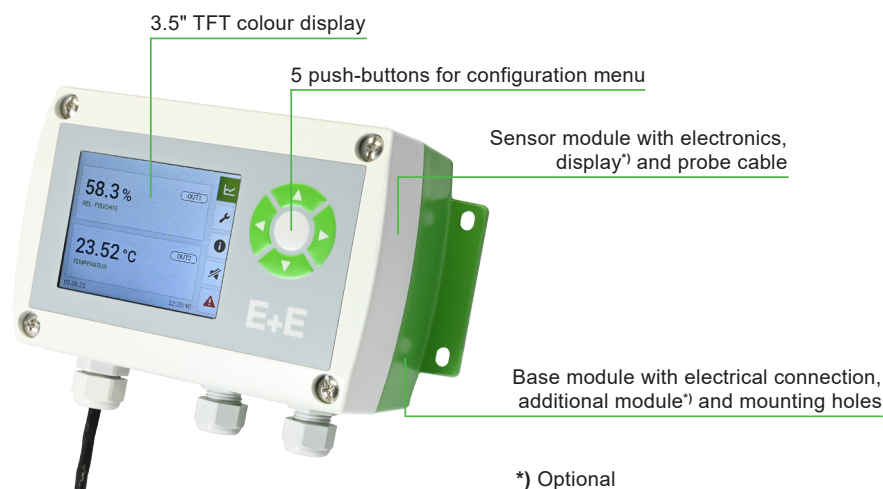

Fig. 1 HTS801 perspective view

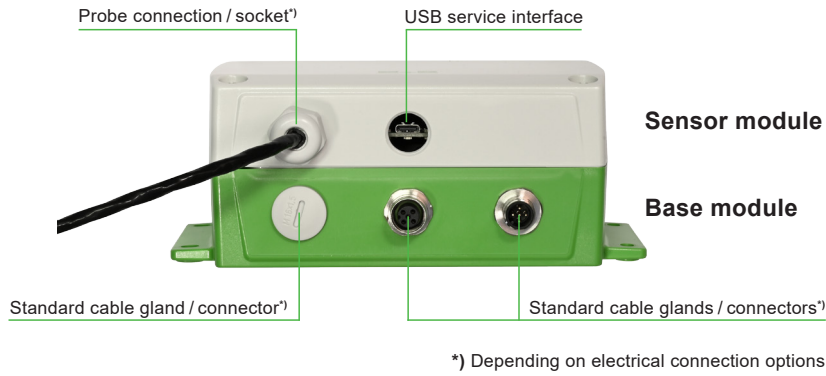

Fig. 2 HTS801 connector-side view

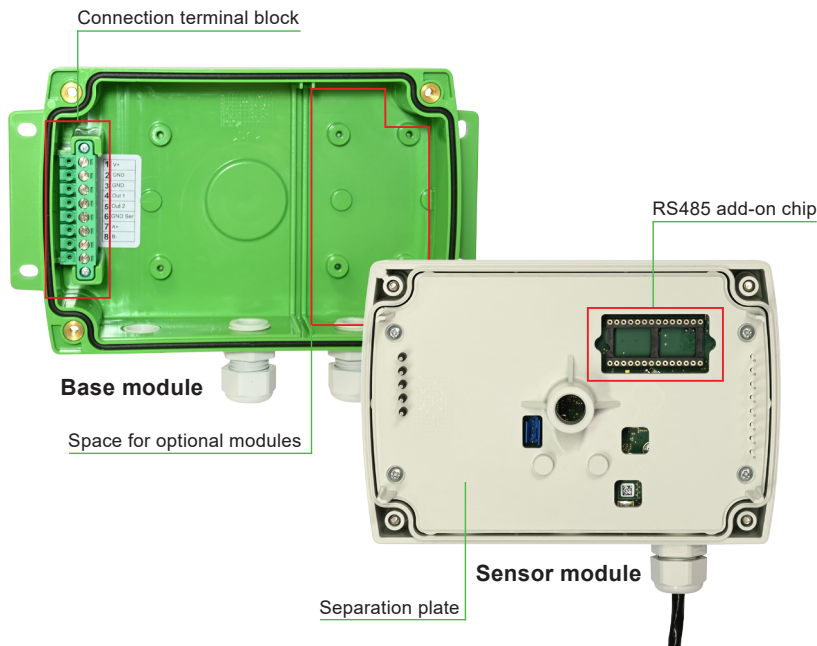

Fig. 3 HTS801 modular polycarbonate enclosure inside view

3.3 Configuration Interface

The HTS801 is ready to use and does not require any configuration by the user. The factory setup of HTS801 corresponds to the type number ordered. Please refer to the datasheet at www.epluse.com/hts801. If needed, the user can change the factory setup with the

- Free PCS10 Product Configuration Software.
Please refer to chapter 6.1 PCS10 Product Configuration Software.
- Display and push-buttons (if the optional display is selected)
Please refer to chapter 1.2.1. General Safety Instructions.
- Modbus RTU protocol (if the RS485 option is selected).
Please note that configuration is limited to the Modbus communication settings.
Please refer to chapter 6.2 RS485 Digital Interface.

3.4 Operation and Heating Modes

3.4.1. Overview Operation Modes and Types

Operating Mode	HTS801 Type	Use in environments with	Function Trigger
Condensation Guard (CG)	T5 / T9 / T10	Temporary condensation	RH setpoint ¹⁾
High Humidity Guard (H ² G)	T7 / T17 / T28	Continuous high humidity and condensation	Always on

1) Factory setting: acc. to ordering guide

3.4.2. Automatic ReCover (ARC) against Chemical Pollution

When capacitive humidity sensing elements are exposed to chemical pollution (e.g. detergent residues), the presence of foreign molecules can distort the measurement reading of the sensor. With the ARC function foreign molecules can be evaporated from the sensing element by brief and intensive heating.

All HTS801 types support the ARC function.

i PLEASE NOTE

Before a recalibration is done after an ARC cycle, reconditioning of the sensing element is recommended. For best reconditioning, please allow 2 free calibration cycles between 15 %RH and 90 %RH in steps of ~20 %RH and 20 min stabilisation time.

The start of the ARC function can be triggered as follows:

Manual: by using PCS10 or via display and push-buttons. A manual start of the ARC function is recommended when

- chemical pollution on the sensing element is expected (cleaning/sterilization)
- measurement readings deviate significantly from a calibration reference.

Cyclic: by using PCS10 or order code option ARC1 (24 h), ARC can be configured to start periodically at a certain time interval.

The cyclic option can be extended to include an automatic start at power on. This function can be switched on and off via PCS10, display and push-buttons or using order code option ARC2 (24 h power on).

Periodic heating shall be used to minimize drift effects in applications with high chemical pollution. The ideal cycle time depends on the type of pollution and its concentration and has to be determined empirically.

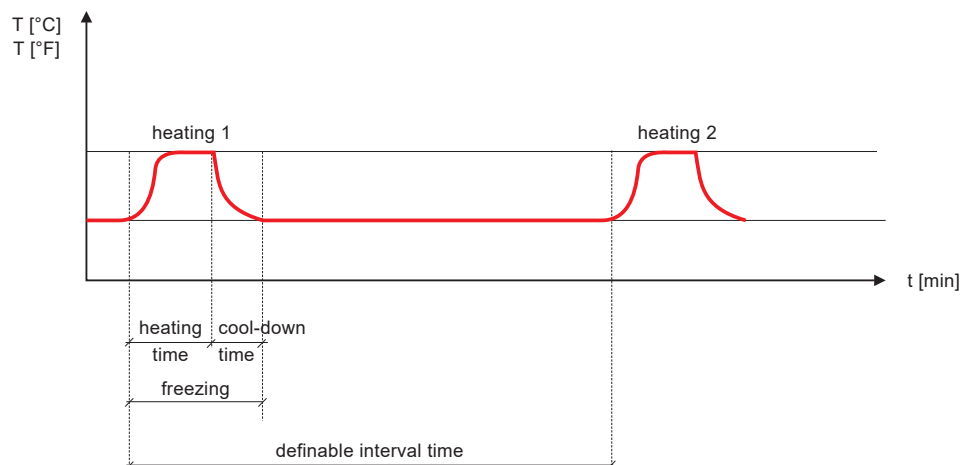

Fig. 4 ARC cycle

External: by using the optional ARC module the function can be activated using an external signal see chapter 3.5.3. ARC Module (Option AM1). RS485 or Ethernet with Modbus commands can be used to start ARC as well.

The ARC parameters can be configured via PCS10 or display and push-buttons:

Heating duration: Defines the time in which the monolithic measurement cell is intensively heated. A heating time of at least 20 minutes (20 min = factory setting) is recommended if chemical pollution has occurred.

Recovery duration: The cool-down time is necessary for the sensing element to cool back down to ambient temperature. The cool-down time should be >3 minutes (3 min = factory setting) in order to prevent measurement errors.

During the ARC process (heating and cool-down time) the values on the outputs are frozen. In other words, the measuring values at the outputs are kept constant during the ARC cycle.

The orange LED D5 at the main PCB near the USB interface is permanently lit during the ARC process. An orange frame and text on the display also indicates the ARC process. On the status page of the display, the remaining ARC process time in seconds is displayed.

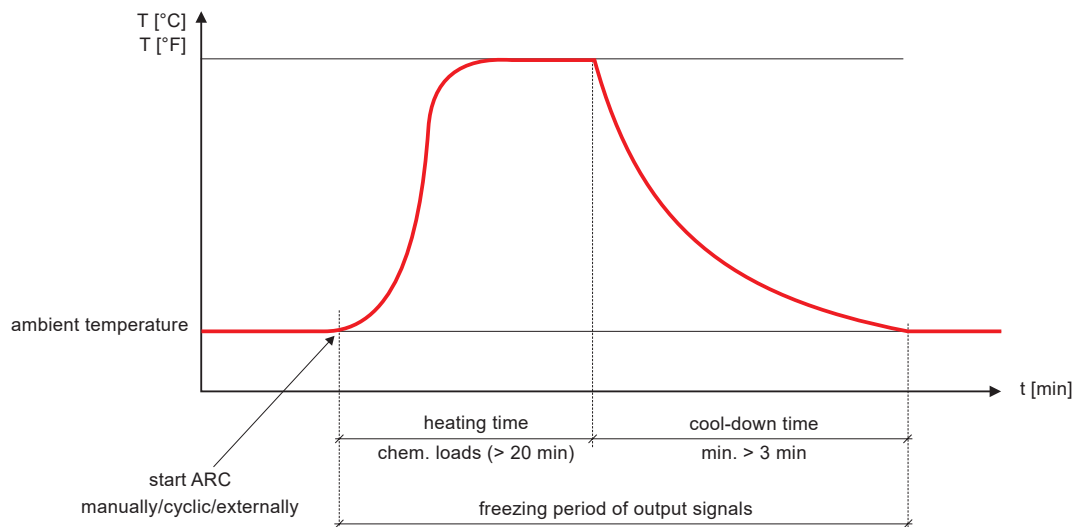

Fig. 5 ARC process in detail

i PLEASE NOTE

If the defined cool-down time is too short, the measurements may be incorrect.

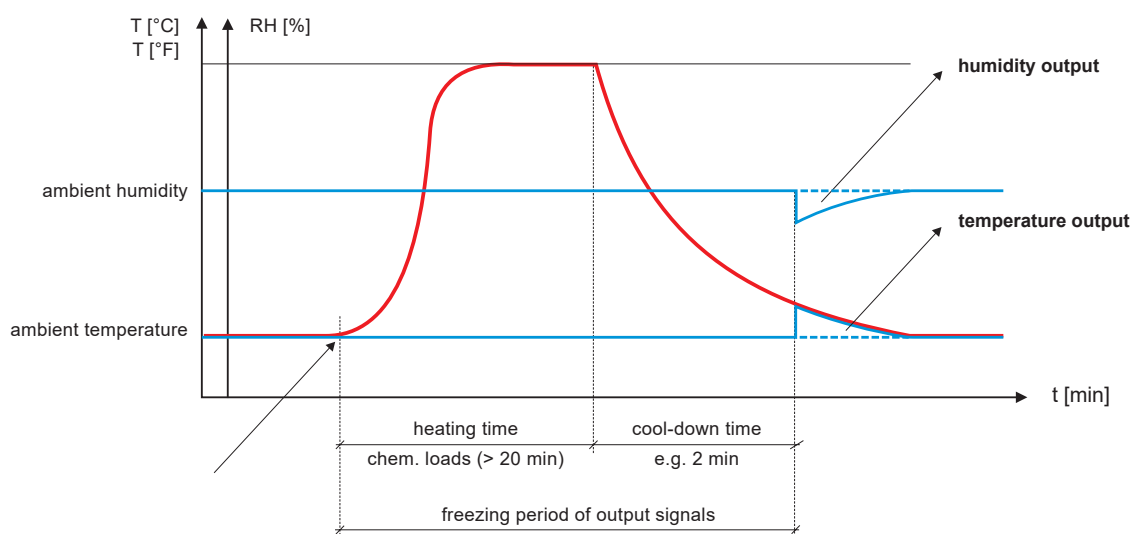

Fig. 6 ARC cycle with cool-down time too short

3.4.3. Condensation Guard (CG) against Temporary Condensation

Temporary condensation on the sensing element in highly humid environments is eliminated when a specified RH set point (factory setting: acc. to order code) is reached. By intensive heating of the sensing element for 10 seconds occurring dew is evaporated. Due to its monolithic structure, the sensing element cools off quickly within approximately 3 minutes and returns to its measurement function.

If condensation is still detected after the CG process, it restarts immediately or after a predefined lock time.

During the complete heating and cool-down process, the values on the outputs are frozen. In other words, the measuring values at the analog outputs are kept constant during the CG cycle.

The following HTS801 types support the Condensation Guard: T5 / T9 / T10.

i PLEASE NOTE

The lock time has to be set according to the application needs. A too short lock time might result in permanent freezing of the outputs.

The CG function can be preconfigured using the order code options. The lock time is configurable.

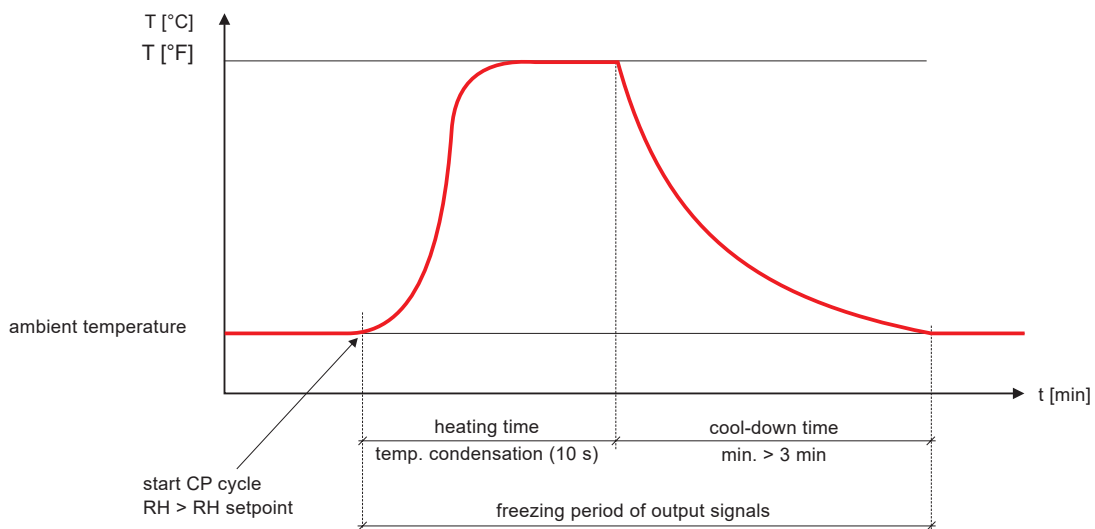

Fig. 7 CG process in detail

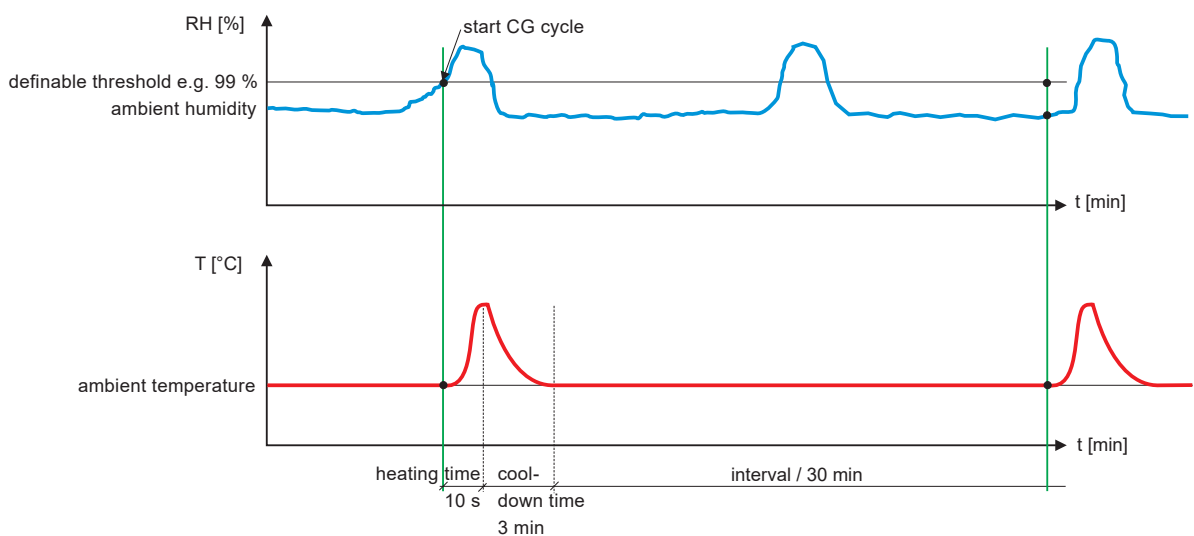

Fig. 8 CG cycles with a lock time of 30 min

i PLEASE NOTE

When heating has ended, the system blocks any subsequent heating for 30 minutes. In other words, if the ambient humidity remains above the defined set point after the initial heating, the next heating starts again after 30 minutes.

3.4.4. High Humidity Guard (H²G) against Continuous High Humidity and Condensing Conditions

In environments with continuous high humidity even the smallest deviations between the temperature of the sensor head and the ambient temperature can cause condensation. Dew on the RH / T sensing element influences the measurement accuracy and increases the risk of deposits on the active sensor surface that lead to parallel resistances and parasitic capacitances.

The dual heating system of the HTS801 prevents both: condensation on the RH sensing element and on the probe body by a regulated heating strategy. This leads to very short response time and fast recovery after condensing conditions. Furthermore, it enables accurate RH measurement even under continuously high humidity and condensing conditions. RH and T can be determined precisely with the help of the heated monolithic sensing element and the calculated dew point. The relative humidity near condensation is determined with the T value of an additional T sensor of Type T17 / T28.

The following HTS801 types incorporate the dual heating system:

T17: with additional T Sensor included for RH measurement

T28: with additional T Sensor included for RH measurement in meteorological applications

T7: one probe design for Td measurement only

3.5 Optional Features**3.5.1. TFT Colour Display**

This option includes a 3.5" TFT colour display and push-buttons for full configuration.

Configuration Menu

Detailed information on the configuration menu see chapter 11 Appendix: Display Menu Structure.

Menu

Data logging	Configuration of the data logger/graph - sampling rate graphs
Display settings	Display layout - measurands brightness orientation display alarm
Analog output	Output configuration - mode measurands scaling error indication
Heating mode settings	ARC and CG configuration - activation deactivation parameters
Alarm output*	Relay configuration - mode set points state
Customer adjustment	Adjustment - 1 and 2 point humidity/temperature adjustment reset to factory adjustment calibration status
Modbus settings*	Configuration of Modbus RTU data transmission
IP settings*	Configuration of Ethernet module
Device settings	Settings - language date, time parameters password protection
Status	Status and device information

* Menu only available with the corresponding optional module.

Fig. 9 Principal configuration menu structure

i CONFIGURATION HINT

Display alarms can be configured via display and push-buttons only. Configuration is to be done in the "Display settings" menu.

The HTS801 display also includes a data logger with a storage capacity of 20 000 values per measurand or calculated quantity.

During the first 5 seconds after display start-up, the data logger and the configuration menu are initialized.

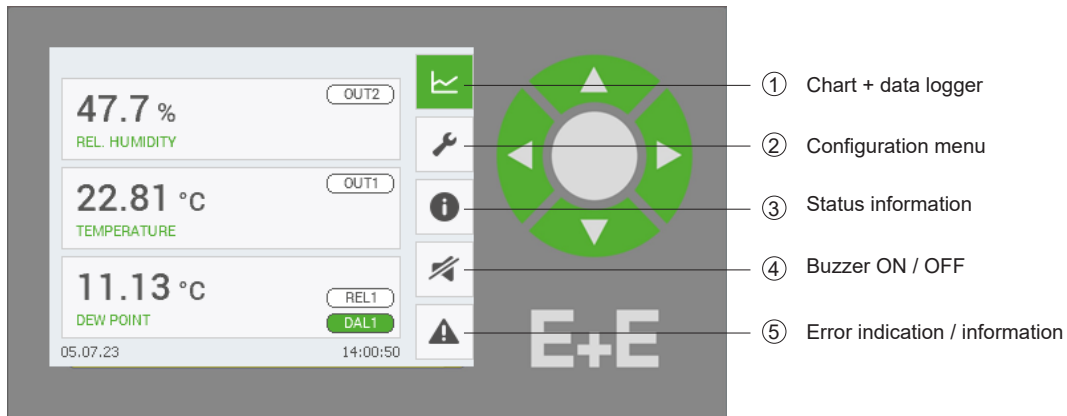

Fig. 10 Control panel with display and push-buttons

Data Logging

The TFT display with the integrated data logging function saves all measured and calculated values to the internal memory. The data logger has a real time clock (UTC time) with a battery back-up.

NOTICE

Changing the UTC time erases all stored data.

The data logger can save 20 000 values for each measurand. The logging interval is user configurable from 1 second to 12 hours. The data logging menu is also used to select the data points that make up the graph and for scaling, see chapter 11.2, Fig. 47 Data logging.

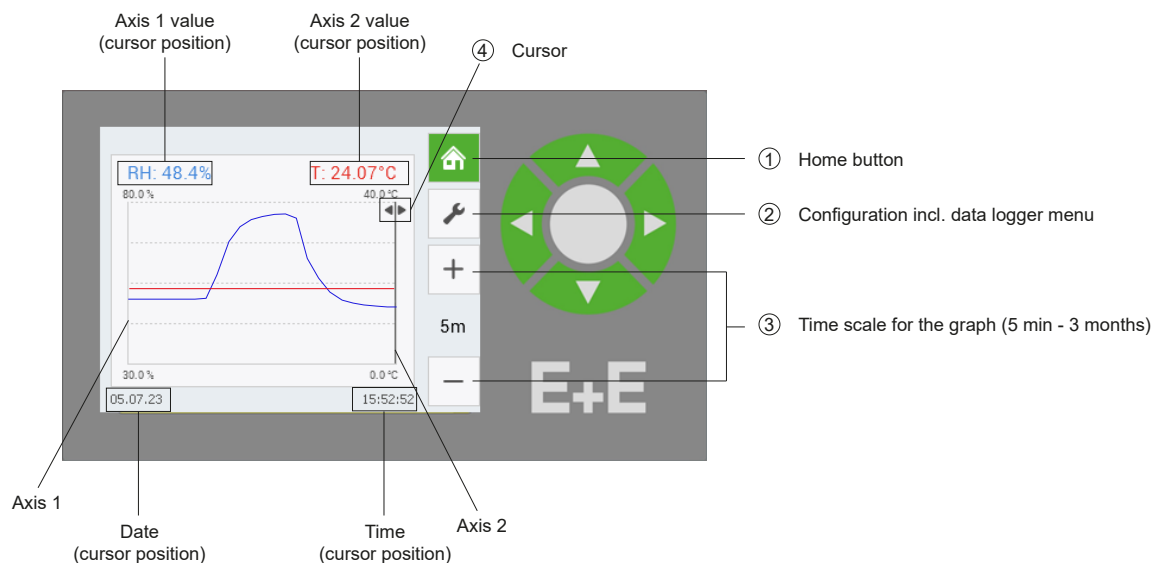

Fig. 11 Data logging

Each point in the graph represents a logged value. The points are connected by linear interpolation.



Fig. 12 Data logger graph

The data logger memory works according to the first in first out (FIFO) principle: new data is stored while the oldest data is deleted. The latest 20 000 logged values are available in the internal memory.

The logged data can be downloaded with PCS10 Product Configuration Software as .csv file by choosing the measurands and the time period.

Status Information

The status information shows all actual HTS801 settings and measured values.

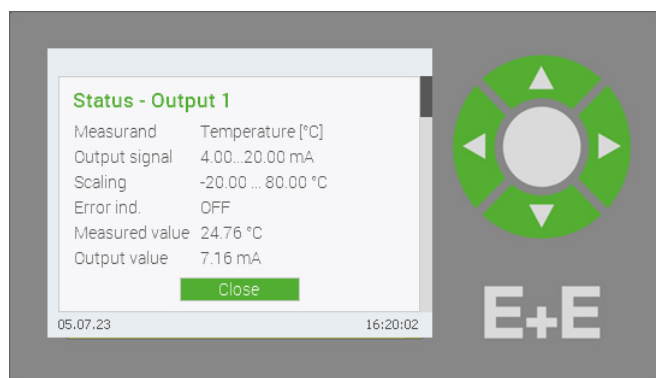

Fig. 13 Status information

Buzzer

If a previously configured limit value is violated, a buzzer sounds periodically. This buzzer can be switched off or on here. Factory default is on.

Error Indication

As soon as an error occurs, an indication shows the error code.

3.5.2. rapidX Smart Probe (Option PC7)

The HTS801 with PC7 option features the intelligent pluggable rapidX probe. The rapidX smart probe enables a plug-and-play probe exchange during operation without any configuration, adjustment or calibration. The sensing element data of the rapidX smart probe is determined in the E+E RH factory calibration systems. Upon connection to the HTS801, the probe automatically uploads its specific parameters to the HTS801 electronics.

This enables simple maintenance procedures at the customer's site without "down time" due to cost-intensive recalibration/repair and even without manual parameterization of the new probe. The smart rapidX probe enables quick replacement without any tools at any time, even during operation (hot-swap). Please refer to chapter 8 Spare Parts / Accessories.

i PLEASE NOTE

Replacing a rapidX probe results in an additional uncertainty in the RH measurement. This is due to the variation of the capacitive and resistive coupling at the connector. The additional uncertainty after a rapidX probe replacement is typically $< \pm 0.15\% \text{RH}$ @70 %RH and $< \pm 0.05\text{ }^\circ\text{C}$.

To ensure the initial accuracy of the HTS801, an adjustment after the rapidX smart probe exchange is recommended.

If rapidX smart probes with different cable lengths are exchanged on an HTS801 (e.g. smart probe change from 10 m to 1 m cable length), an adjustment must be carried out.

For Type T17 only the RH probe is exchangeable. The T probe is fixed.

3.5.3. ARC Module (Option AM1)

The additional circuit board located in the lower part of the HTS801 enclosure offers the possibility to start the ARC heating function with external signal.

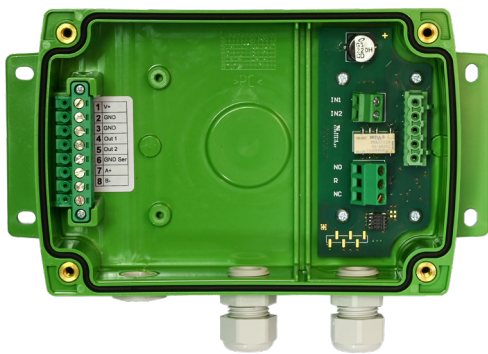

Fig. 14 ARC module in polycarbonate enclosure

During the ARC process the orange LED 5 at the main PCB near the USB interface is permanently lit (refer to Fig. 42). An orange frame and text on the display also indicates the ARC process. The remaining time span of the ARC process is indicated in seconds in a device information register. Please refer to chapter 6.2.1. Modbus RTU Setup. On the status page of the optional display, the remaining seconds of the ARC process are displayed.

Heating process and trigger parameters can be set and changed with the PCS10 and via the display and push-buttons.

Electrical Connection**Terminal "Input": External signal trigger**

IN1 signal (24 V DC; 10 mA)

IN2 GND

Terminal "Status": Feedback signal to the external control

NO / R / NC

The NO contact is closed during the heating process, otherwise opened.

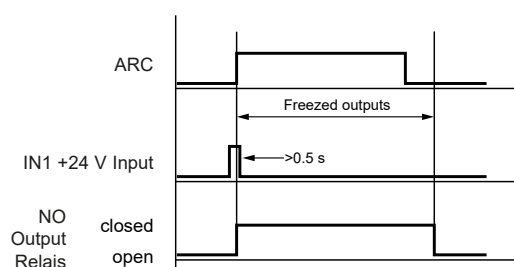

Fig. 15 ARC timing

3.5.4. Alarm Module (Option AM2)

The module offers two freely configurable relay outputs for alarm or control purposes. Various operation modes are available including switch hysteresis, switch window and error indication. The error modes can be configured independently from each other. The measurands at the outputs as well as switching points, hysteresis and the normal state (standard / inverted) can be set via PCS10 Product Configuration Software or using the push-buttons (see chapter 11.3 Optional Menus, Fig. 54 Alarm output).

Switch Hysteresis Mode

The switching behavior is determined by entering a switching point and an associated hysteresis value.

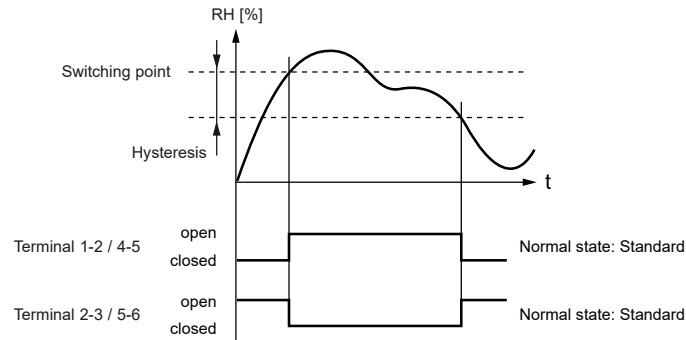

Fig. 16 Example hysteresis mode on both alarm outputs using normal state standard

Additionally, detected errors are signaled at the alarm output.

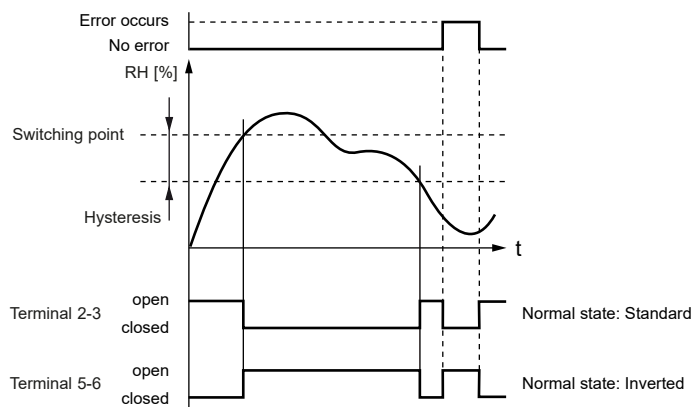

Fig. 17 Example of hysteresis mode with error occurring.

Switch Window Mode

The switching behavior is determined by entering two switching points and two associated hysteresis values.

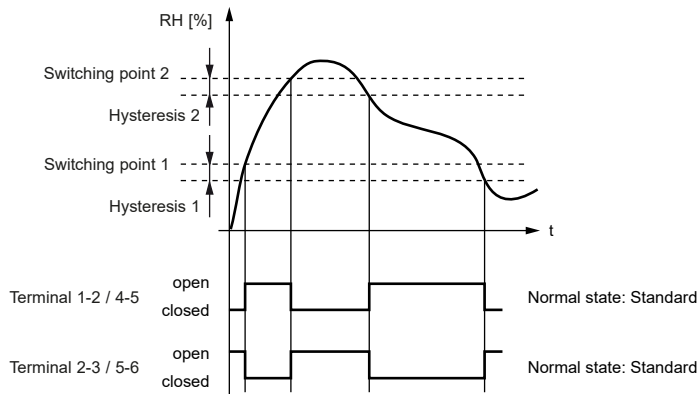

Fig. 18 Example window mode on both alarm outputs using normal state standard

Additionally, detected errors are signaled at the alarm output.

Error Indication Mode

When error indication mode is selected, various errors will trigger the alarm output.

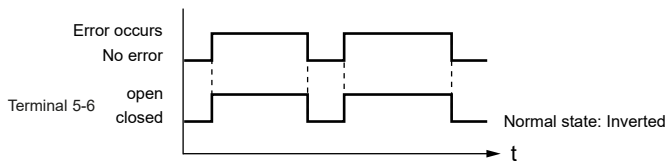

Fig. 19 Example of error mode on relay 1 using normal state inverted.

i PLEASE NOTE

An alarm output in this operation mode is used for error indication only (no combination with switching points possible).

Electrical Connection and Switch Load

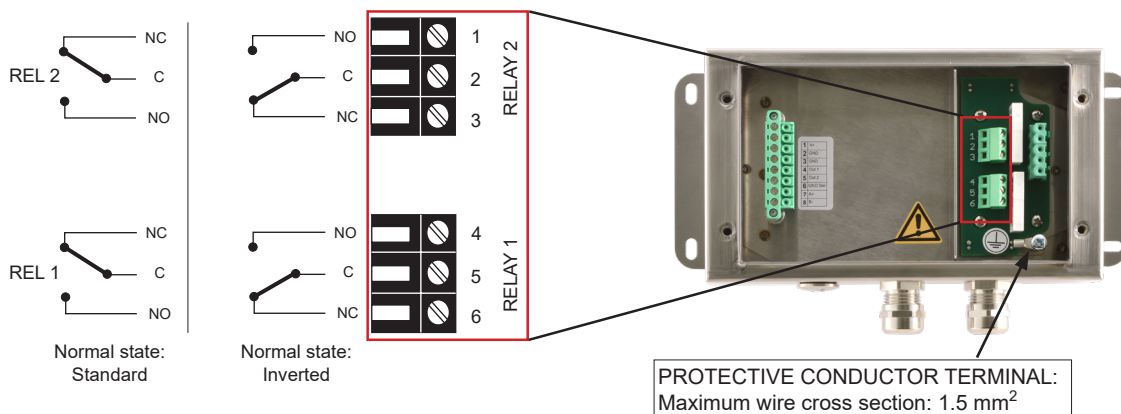

Fig. 20 Alarm module (option AM2)

⚠ WARNING

The metal enclosure must be grounded during operation. National regulations for installation must be observed!

Switch Load

Max. switch load	250 V AC / 6 A 28 V DC / 6 A
Min. switch load	12 V / 100 mA

Tab. 1 Maximum and minimum switch loads

⚠ WARNING

No overcurrent and short circuit protection. Both relays shall be connected to either high oder low voltage.

3.5.5. Integrated Power Supply 100 - 240 V AC (Option AM3)

This module allows the HTS801 to be powered with 100 - 240 V AC (50/60 Hz), 2 VA.

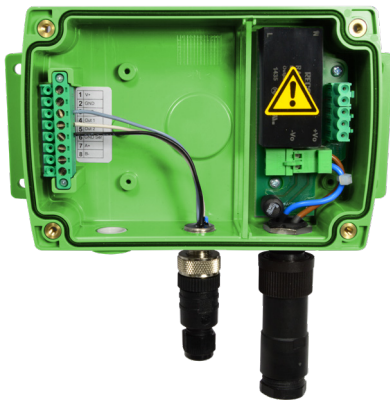

Polycarbonate enclosure



Stainless steel enclosure

Fig. 21 Power supply module (option AM3)

⚠ WARNING

The AM3 option includes a 1.25 A fuse on the 100 - 240 V side. This fuse must not be replaced by the user, only by the E+E after sales service.

The protection of the supply cable against excess current and short-circuit must be designated to a wire cross section of 0.8 mm² (AWG 18) (6 A fuse).

The metal enclosure must be grounded during operation.

All national regulations for installation shall be observed!

3.5.6. RS485 Module - Modbus RTU (Option J3)

Up to 32 HTS801 sensors with Modbus RTU interface can be connected in an RS485 bus system (1 unit load).

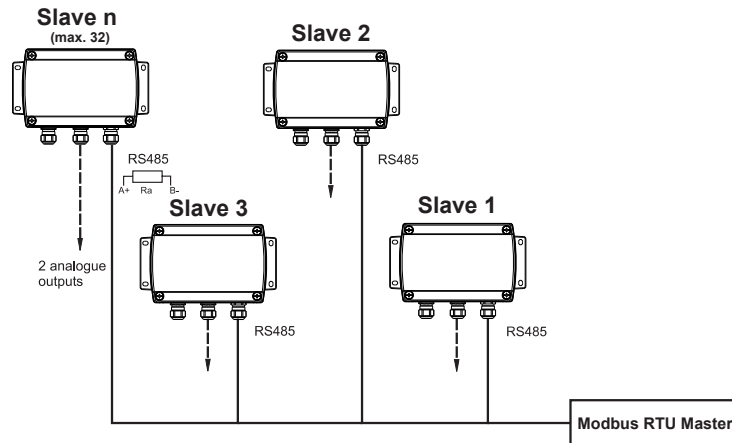

Fig. 22 2-wire RS485 bus

i PLEASE NOTE

Both ends of the bus shall be terminated with a resistor $R_a = 120 \Omega$.

The setup of the Modbus RTU communication can be performed via PCS10 Product Configuration Software or via display and push-buttons, see chapter 11.3, Fig. 55 Modbus settings.

Modbus RTU protocol settings

	Factory settings	User selectable values (via PCS10)
Baud rate	9 600	9 600, 19 200, 38 400, 57 600, 76 800
Data bits	8	8
Parity	Even	None, odd, even
Stop bits	1	1, 2
Modbus address	230 (0xE6)	1...247

Tab. 2 Modbus RTU protocol settings

i PLEASE NOTE

The recommended settings for multiple devices in a Modbus RTU network are 9 600, 8, even, 1.

3.5.7. Ethernet Module - Modbus TCP (Option J4)

The Ethernet module features power over Ethernet (PoE) and RJ45 connector with IP65 protection rating.

i PLEASE NOTE

The Ethernet connection shall be disconnected before opening the enclosure.

Available TCP and UDP Ports

- Modbus TCP: Port 502
See “Modbus TCP/IP implementation guide” which can be found at www.modbus.org/docs/Modbus_Messaging_Implementation_Guide_V1_0b.pdf.

The unit identifier of the MBAP header is not used and can be any value from 0 to 255.

- HTTP-Webserver: Port 80
For a quick communication check, enter the desired IP address in a web browser and connect with the HTS801 Ethernet module's Webserver.

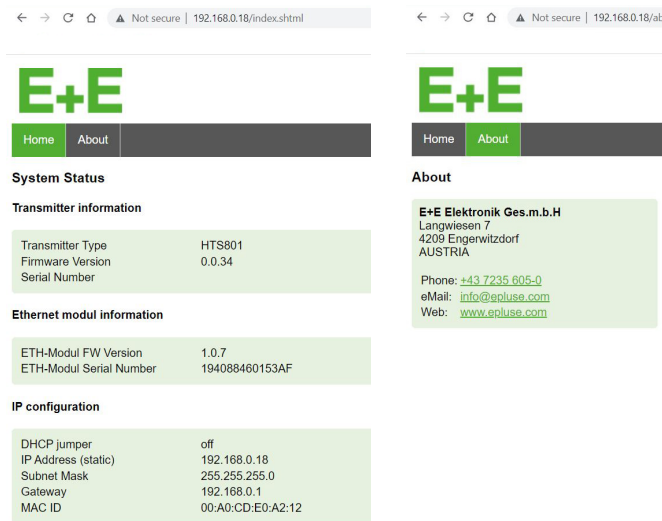

Fig. 23 E+E net web interface screenshots

Alternatively, send an ICMP echo request (“ping”) to check correct communication settings.

IPv4 Settings

	Factory settings
IP Address	192.168.0.64
Subnet Mask	255.255.255.0
Gateway	192.168.0.1
DNS	192.168.0.1

Tab. 3 IPV4 settings

DHCP options can be set with jumper on the electronics board, refer to Fig. 24. Factory setting: DHCP disabled (static IP).

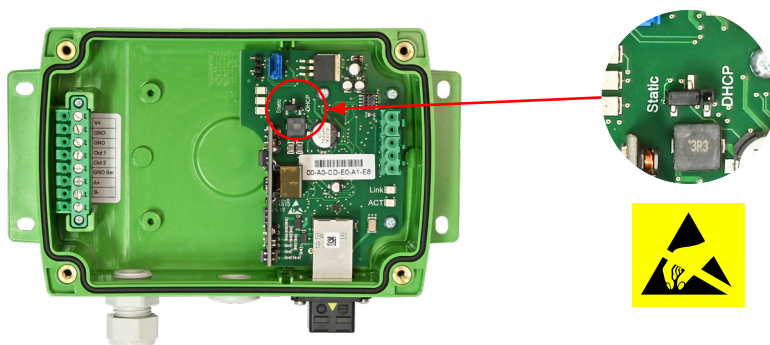

Fig. 24 Ethernet module - DHCP setting

The setup of the Modbus TCP communication can be performed via PCS10 Product Configuration Software or via display and push-buttons, see chapter 11.3 Optional Menus Fig. 56 IP settings.

Modifying the IP address via PCS10 or display is possible only when the DHCP jumper is set to “Static”. Otherwise the IP settings are read-only.

NOTICE

Supported Ethernet standard: 802.3i/u/x and af.
IPv6 is not supported.

3.5.8. Retrofit with Ethernet module

HTS801 with polycarbonate enclosure can be retrofitted with an Ethernet module. Before retrofitting, please make sure that the device firmware is updated to the latest version by using PCS10.

The Ethernet module is automatically detected by HTS801 at power on. Module setup can be performed via PCS10 Product Configuration Software or via display and push-buttons.

The module is available as an accessory (please refer to chapter 8 Spare Parts / Accessories).

3.6 Dimensions

Values in mm / inch

Enclosure

Polycarbonate

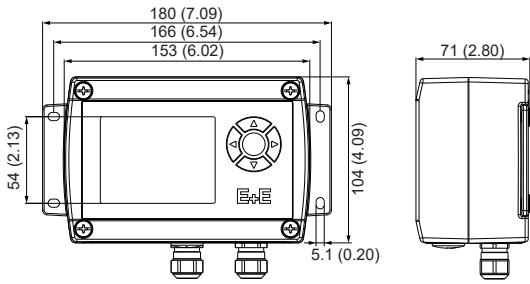

Stainless steel

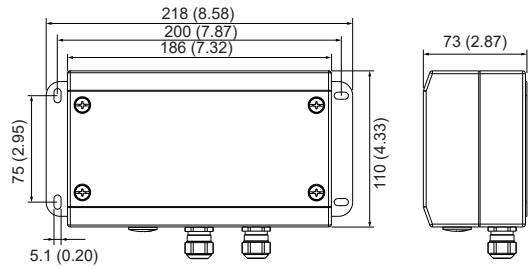

Type T5 Probe

Up to 180 °C (356 °F)

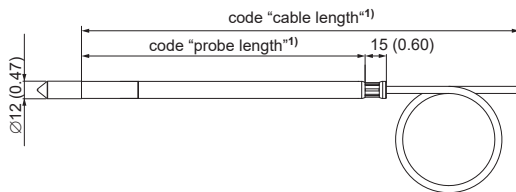

Type T7 Probe

Pressure-tight up to 20 bar (300 psi) for Td measurement

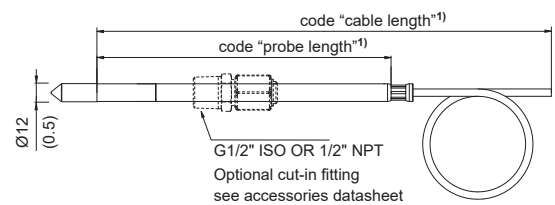

Type T9 Probe

Pressure-tight up to 300 bar (4 350 psi) with cut-in fitting

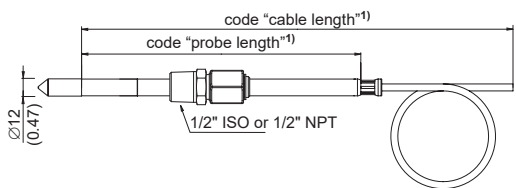

Type T10 Probe

Pressure-tight up to 20 bar (300 psi) with sliding fitting

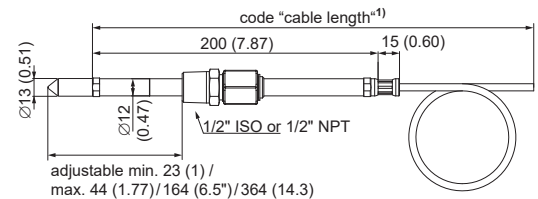

Type T17 Probe

Pressure-tight up to 20 bar (300 psi) with optional cut-in fitting

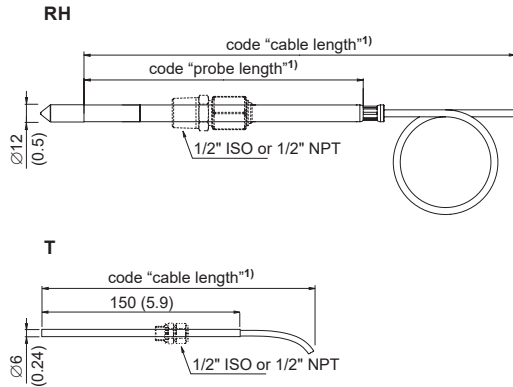

Type T28 Probe

For meteorological applications

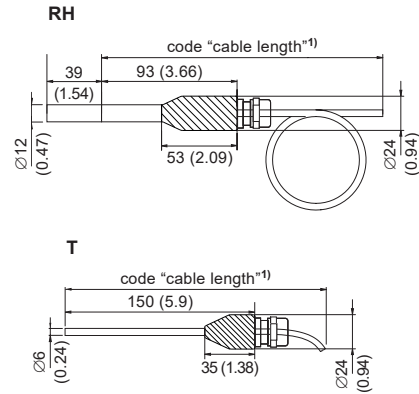

4 Mounting and Installation

4.1 Sensor Enclosure

Mounting with Screws

- Drill the mounting holes according to the corresponding mounting pattern below.
- Mount the base module of the enclosure with 4 screws (screw diameter < 4.2 mm (0.2"), not included in the scope of supply).

Values in mm (inch).

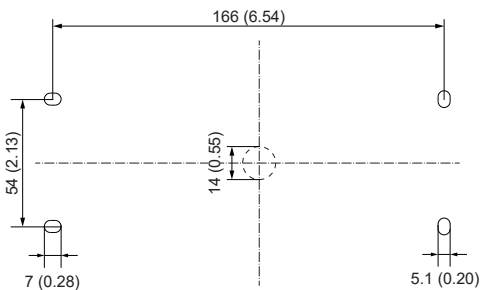

Fig. 25 Drilling pattern of polycarbonate enclosure

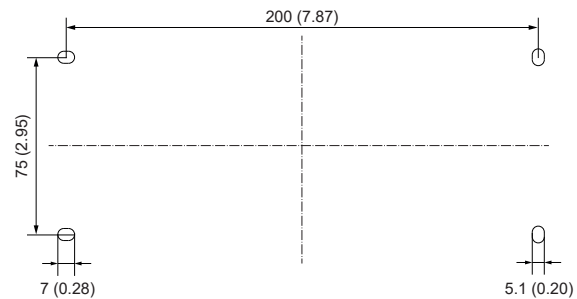

Fig. 26 Drilling pattern of stainless steel enclosure

DIN Rail Mounting of the Polycarbonate Enclosure

- Mount the two DIN rail brackets onto the base module.
(HA010203, to be ordered separately, see chapter 8 Spare Parts / Accessories)
- Snap in the enclosure onto the DIN rail.

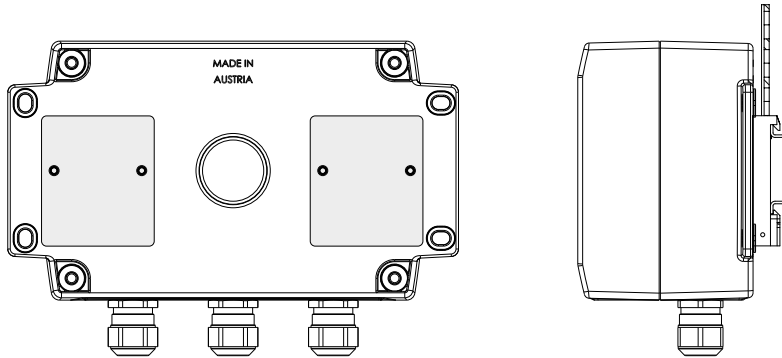

Fig. 27 DIN rail installation

4.2 General Information for Mounting HTS801 Sensing Probes

i PLEASE NOTE

For accurate measurement it is of paramount importance to avoid T gradients along the probe. In case of large T difference between the front and the back of the probe, it is highly recommended to insert the probe completely into the process. Should this not be possible, place a thermal isolation layer on the part of the probe outside the process (on the cable side).

i PLEASE NOTE

The sensing probe must be mounted horizontally or vertically, pointing downwards. If possible, a drip sheet should be fitted for each mounting.

i PLEASE NOTE

For probe hanging onto its cable from the ceiling in applications where condensation is likely to happen it is important to avoid condense water getting from the cable to the probe and into the sensing head. For this use the drip water protection (see chapter 8 Spare Parts / Accessories).

i INSTRUCTIONS FOR INSTALLATION IN A HIGH-HUMIDITY ENVIRONMENT

If the process temperature differs significantly from the ambient temperature, the sensing probe should be fully emerged in the process to avoid incorrect measurements and condensation problems on the sensor head due to thermal conductivity.

It is recommended not to bring the sensing probe and colder metal parts in direct contact in order to avoid condensation problems caused by thermal conductivity.

4.3 Remote Sensing Probe Type T5

For mounting the probe into a separation wall use the stainless steel mounting flange. The immersion depth is adjustable. The probe shall be mounted horizontally.

Values in mm (inch)

Probe into separation wall

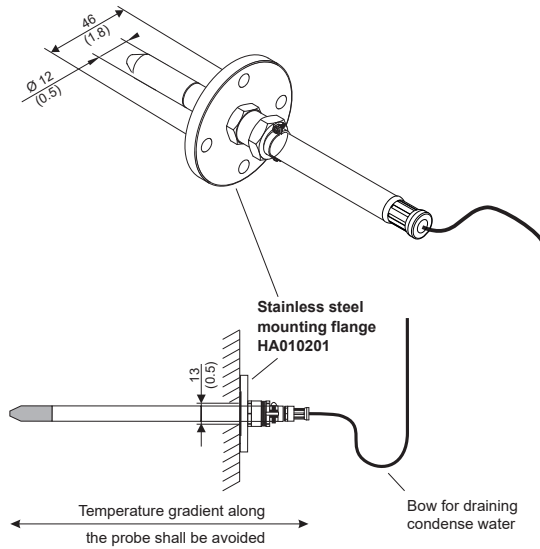

Hanging probe

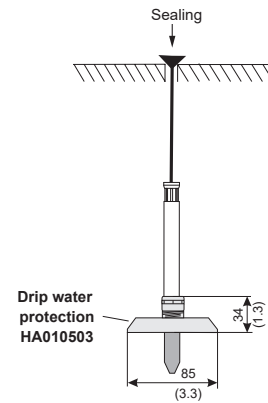

Fig. 28 Mounting the remote probe of HTS801-T5

The stainless steel mounting flange is not appropriate for pressure-tight mounting. For pressure-tight requirements use HTS801-T10.

4.4 Remote Sensing Probe Type T7

4.4.1. Installation at normal pressure

For mounting the probe into a separation wall use the stainless steel mounting flange. The immersion depth is adjustable. The probe shall be mounted horizontally.

Values in mm (inch)

Probe into separation wall

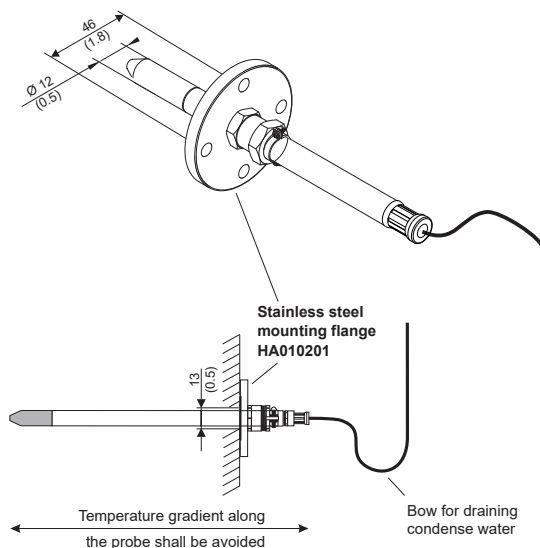

Hanging probe

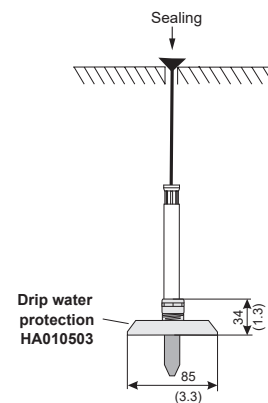

Fig. 29 Mounting the remote probe of HTS801-T7

4.4.2. Pressure-tight Installation

For pressure-tight installation up to 20 bar (300 psi) a pressure-tight feedthrough is available as an accessory (see chapter 8 Spare Parts / Accessories).

⚠ WARNING

General safety instructions for pressure-tight installation

The installation, commissioning and operation of the HTS801-T7 may be performed by qualified staff only. Special attention shall be paid to the correct installation of the probe into the process. In case of inappropriate installation there is the risk for the probe to be suddenly expelled due to the pressure in the process.

Bending over the sensing probe should be avoided under any circumstances!

Make sure that the surface of the probe is not damaged during installation. A damaged probe surface may lead to damaged seals and consequently to leakage and pressure loss.

The probe is rated with leakage rate B according to EN12266-1.

⚠ CAUTION

Safety instructions for pressure-tight feedthrough:

Do not assemble the probe and tighten the feedthrough if the plant is under pressure.

The plant must not be vented by releasing the nut (A).

Use appropriate seal on conical probe threads.

Never rotate the screw connection body (B) but hold the screw connection body (B) securely and turn the nut (A).

Avoid unnecessary disassembly of pipe screw connections.

Position the cut in fitting >75 mm (2.95") from the end of the filter cap to the end of the fitting!

For a probe length of 65 mm a cut in fitting is not possible.

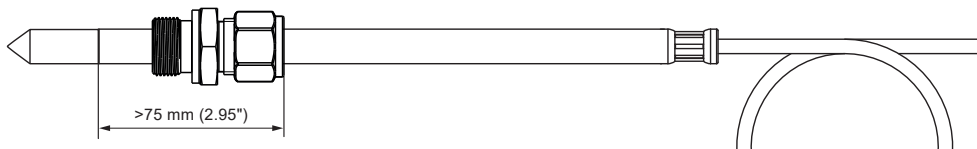

Installation instructions

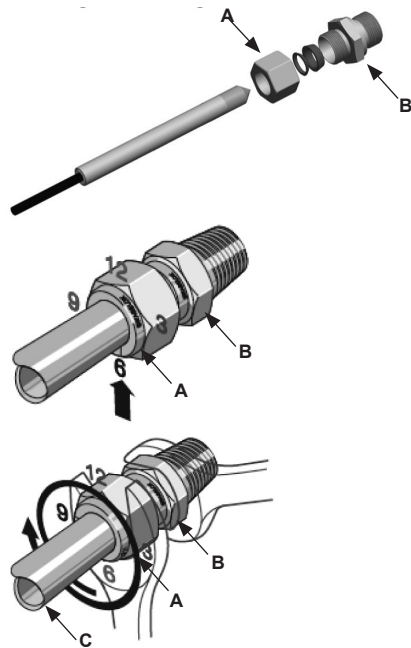

- Tighten the nut (A) finger-tight.
- Mark the nut (A) at 6 o'clock position.
- Hold the screw connection body (B) tight and tighten the nut (A) with 1 ¼ turns till 9 o'clock position.

Assembly with high pressure applications and applications with a high security factor:

- Tighten the nut (A) until the probe (C) can no longer be turned by hand and moved axially in the feedthrough.
- Mark the nut (A) at 6 o'clock position.
- Hold the screw connection body (B) tight and tighten the nut (A) with 1 ¼ turns to 9 o'clock position.

Re-mounting:

- Slide the measurement probe with clamping ring into the fitting as far as it goes.
- Tighten the nut finger-tight, then tighten by approx. a ¼ turn using a spanner.

4.5 Remote Sensing Probe Type T9

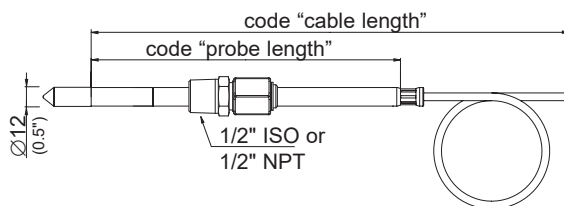

For pressure-tight installation up to 300 bar (4 350 psi) the remote sensing probe type T9 comes with a pressure-tight feedthrough within the scope of supply.

⚠ WARNING

General safety instructions for pressure-tight installation

The installation, commissioning and operation of the HTS801-T9 may be performed by qualified staff only. Special attention shall be paid to the correct installation of the probe into the process. In case of inappropriate installation there is the risk for the probe to be suddenly expelled due to the pressure in the process.

Bending over the sensing probe should be avoided under any circumstances!

Make sure that the surface of the probe is not damaged during installation. A damaged probe surface may lead to damaged seals and consequently to leakage and pressure loss.

The probe is rated with leakage rate B according to EN12266-1.

⚠ CAUTION**Safety instructions for pressure-tight feedthrough:**

Do not assemble the probe and tighten the feedthrough if the plant is under pressure.

The plant must not be vented by releasing the nut (A).

Use appropriate seal on conical probe threads.

Never rotate the screw connection body (B) but hold the screw connection body (B) securely and turn the nut (A).

Avoid unnecessary disassembly of pipe screw connections.

Position the cut in fitting >75 mm (>2.95") from the end of the filter cap to the end of the fitting!

For a probe length of 65 mm (2.56") a cut in fitting is not possible.

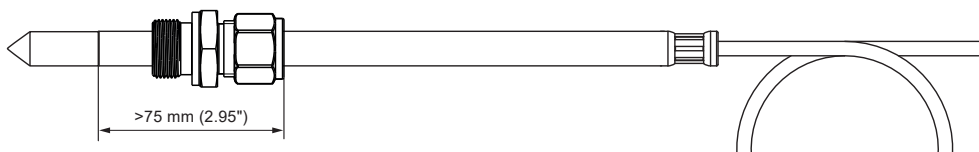
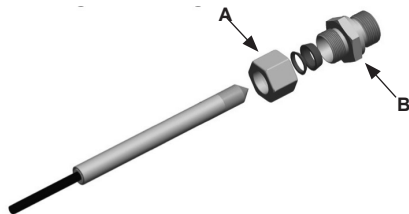
**Installation instructions**

- Tighten the nut (A) finger-tight.
- Mark the nut (A) at 6 o'clock position.
- Hold the screw connection body (B) tight and tighten the nut (A) with 1 ¼ turns till 9 o'clock position.

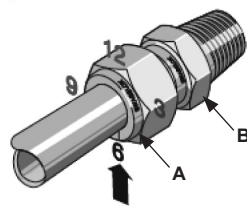
**Assembly with high pressure applications and applications with a high security factor:**

- Tighten the nut (A) until the probe (C) can no longer be turned by hand and moved axially in the feedthrough.
- Mark the nut (A) at 6 o'clock position.
- Hold the screw connection body (B) tight and tighten the nut (A) with 1 ¼ turns to 9 o'clock position.

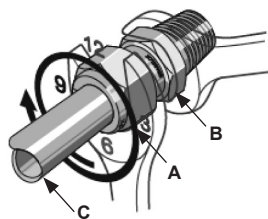
**Re-mounting:**

- Slide the measurement probe with clamping ring into the fitting as far as it goes.
- Tighten the nut finger-tight, then tighten by approx. a ¼ turn using a spanner.

4.6 Remote Sensing Probe Type T10

⚠ WARNING

General safety instructions for pressure tight installation

The installation, commissioning and operation of the HTS801-T10 may be performed by qualified staff only. Special attention shall be paid to the correct installation of the probe into the process. In case of inappropriate installation there is the risk for the probe to be suddenly expelled due to the pressure in the process.

Bending over the sensing probe should be avoided under any circumstances!

Make sure that the surface of the probe is not damaged during installation. A damaged probe surface may lead to damaged seals and consequently to leakage and pressure loss.

The probe is rated with leakage rate B according to EN12266-1.

4.6.1. Installation of the Probe directly in the Process

NOTICE

For direct probe installation shut-off valves shall be placed on both sides of the probe insert (see Fig. 30 Installation of the HTS801-T10 probe directly into the process). This allows the sensor probe to be easily removed for maintenance and calibration.

For direct installation into a pressure chamber make sure that the pressure in the chamber and the ambient pressure are equal before removing the probe. The temperature during probe installation may deviate by max. ± 40 °C (± 72 °F) from the regular temperature during normal operation.

Replace the metal sealing ring (see Fig. 30) by a new one every time before re-installing the probe.

Probe installation steps

1. Close both shut-off valves.
2. Place the sensor probe into the probe insert and adjust the immersion depth.
3. Tighten the lock nut with a torque of 30 Nm.
4. Open the shut-off valves.

⚠ WARNING

Observe strictly the tightening torque. A torque lower than 30 Nm results in a smaller retention force of the clamping sleeve. This leads the risk of sudden expulsion of the sensing probe due to the pressure. A torque higher than 30 Nm may lead to permanent deformation of the clamping sleeve and the sensing probe. This would make the removal and re-installation of the probe difficult or even impossible.

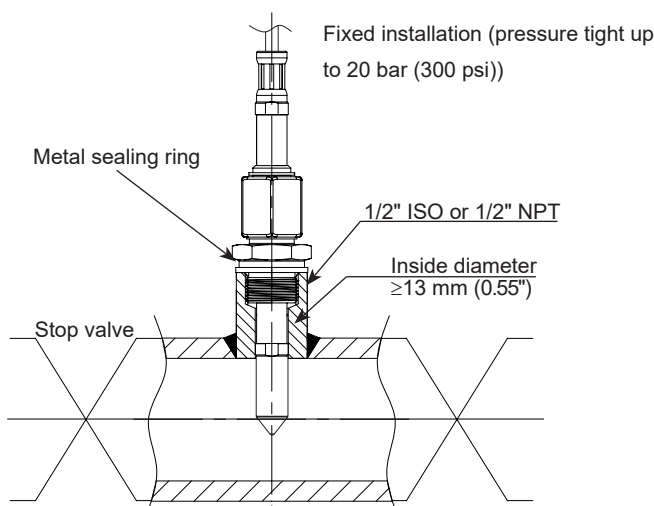

Fig. 30 Installation of the HTS801-T10 probe directly into the process

4.6.2. Installation of the Probe with Ball Valve Set

The ball valve set allows for installation and removal of the probe without process interruption. For mounting into a duct, the ball valve shall be installed perpendicular to the flow direction.

NOTICE

The two metal sealing rings (see Fig. 31 Installation of the probe by utilizing the ball valve set) shall be replaced every time prior to re-installing the probe.

The temperature during probe installation may deviate by max. ± 40 °C (± 72 °F) from the regular temperature during normal operation.

Installation of the probe (see Fig. 31)

1. Install the probe into the ball valve while the ball valve is closed.
2. Open the ball valve.
3. Slide the probe through the ball valve to the desired immersion depth. Depending on the process pressure additional tools may be necessary for pushing the probe into the process. Make sure not to damage the probe and the cable.
4. Tighten the lock nut with a torque of 30 Nm.

⚠ WARNING

Observe strictly the tightening torque. A torque lower than 30 Nm results a smaller retention force of the clamping sleeve. This leads the risk of sudden expulsion of the sensing probe due to the pressure. A torque higher than 30 Nm may lead to permanent deformation of the clamping sleeve and the sensing probe. This would make the removal and re-installation of the probe difficult or even impossible.

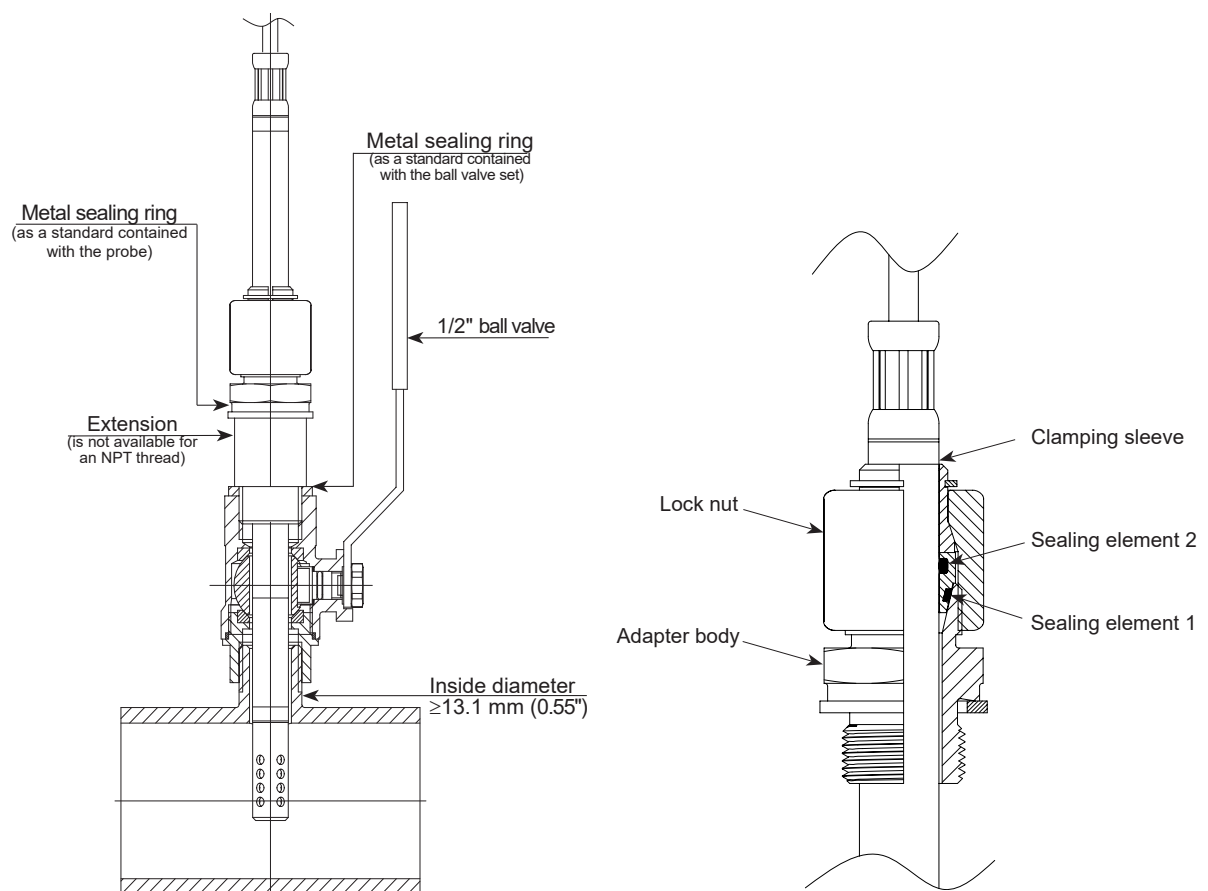

Fig. 31 Installation of the probe by utilizing the ball valve set

Removing the probe

1. Hold firmly the probe to avoid it being suddenly expelled when releasing the lock. Do not bend damage the probe cable.
2. Loosen slowly the lock nut with a spanner (spanner width 24) only till the probe is pushed out by the overpressure in the process. Do not completely loosen the lock nut, but only as much as necessary for the probe to slide.
3. After the probe has been pushed out of the process up to the stop, close the ball valve.
4. Remove the probe from the ball valve.

NOTICE

Observe the correct positioning of the sealing element 1 before reinstalling the probe.

4.7 Remote Sensing Probes Type T17

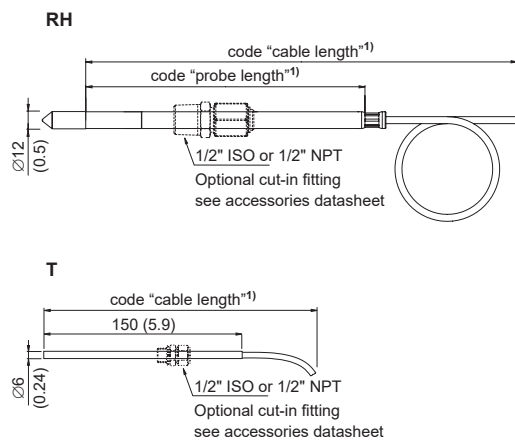

Fig. 32 Remote Sensing Probes Type T17

4.7.1. Installation at Normal Pressure

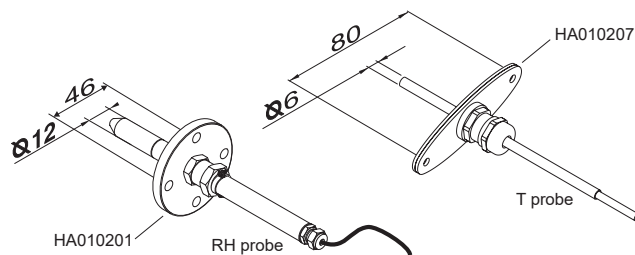

Fig. 33 Mounting of sensing probe with flange (accessory)

A mounting flange 12 mm (1/2") for the humidity probe and a mounting flange 6 mm (1/4") for the temperature probe are available as an accessory. The immersion depth is adjustable.

Order codes:

	RH probe (12 mm (1/2"))	T probe (6 mm (1/4"))
Flange	HA010201	HA010207

4.7.2. Pressure-tight Installation

Mounting of sensing probe with screw connection (accessory)

A 1/2" ISO or a 1/2" NPT screw connection, respectively, is available as an accessory for mounting both sensing probes (6 mm (1/4") and 12 mm (1/2")).

Order codes:

	RH probe (12 mm (1/2"))	T probe (6 mm (1/4"))
1/2" ISO	HA011102	HA011104
1/2" NPT	HA011103	HA011105

For mounting instructions please refer to chapter 4.4.2. Pressure-tight Installation.

4.8 Remote Sensing Probes Type T28

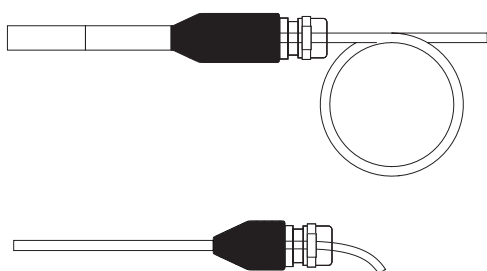

Fig. 34 Remote Sensing Probes Type T28)

The sensing probes type T28 are optimised for application in meteorology. Their rotation symmetric design allows for mounting in a modern ventilated radiation shields, as it is available with HA010508 (please refer to chapter 8 Spare Parts / Accessories).

5 Electrical Connection

NOTICE

The electrical installation of the HTS801 shall be performed by qualified personnel only. Observe all applicable national and international requirements for the installation of electrical devices as well as for power supply according to EN 61140, class III (EU) and class 2 supply (North America).

⚠ WARNING

Incorrect installation, wiring or power supply may cause overheating and therefore personal injuries or damage to property.

For correct cabling of the device, always observe the presented wiring diagram for the product version used.

The manufacturer cannot be held responsible for personal injuries or damage to property as a result of incorrect handling, installation, wiring, power supply and maintenance of the device.

5.1 Electrical Connection and Wiring Overview

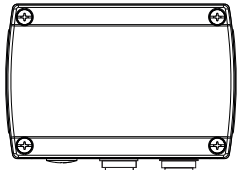
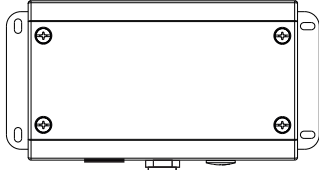
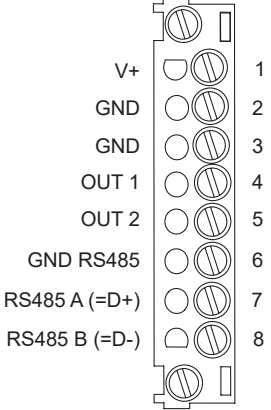
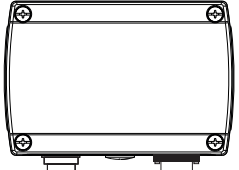
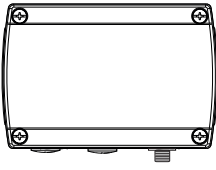
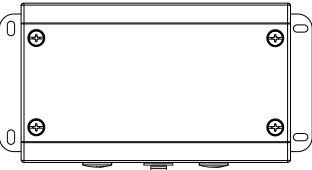
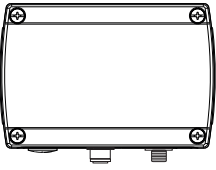
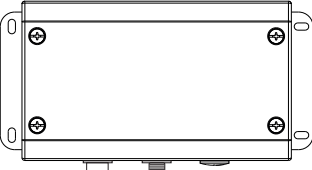
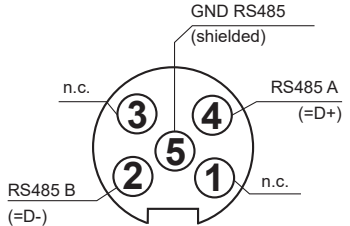
Option	Polycarbonate Enclosure	Stainless Steel Enclosure	Pin Assignment
Cable glands	 <p>2x M16x1.5</p>	 <p>1 x M16x1.5 mounted 1 x M16x1.5 enclosed</p>	
J4	 <p>Ethernet Modbus TCP</p>		
E4	 <p>Power supply + analogue output</p>	 <p>Power supply + analogue output</p>	
E6	 <p>Modbus RTU Power supply + analogue output</p>	 <p>Power supply + analogue output Modbus RTU</p>	 <p>Modbus RTU Socket</p>

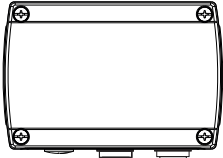
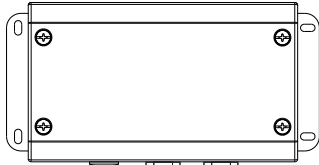
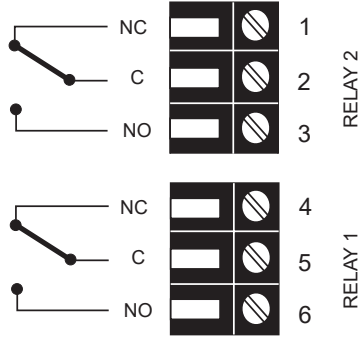
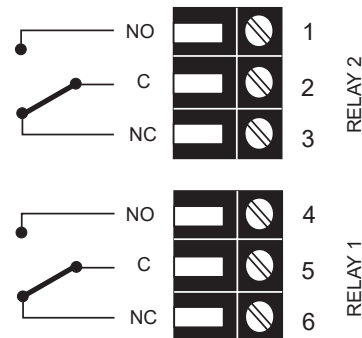
Option	Polycarbonate Enclosure	Stainless Steel Enclosure	Pin Assignment
AM2	 <p data-bbox="512 528 620 555">2x M16x1.5</p>	 <p data-bbox="879 539 987 566">2x M16x1.5</p>	<p data-bbox="1134 277 1497 416">Standard operation mode</p>  <p data-bbox="1166 607 1458 633">Standard operation mode</p> <hr/> <p data-bbox="1134 712 1497 1030">Inverted operation mode</p>  <p data-bbox="1166 1048 1458 1075">Inverted operation mode</p>

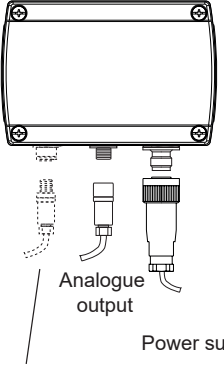
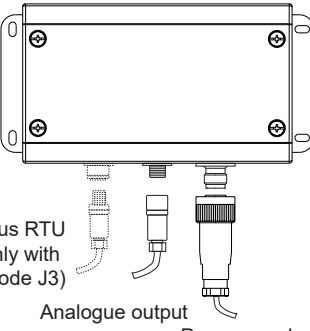
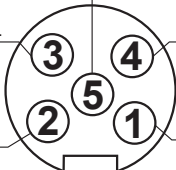
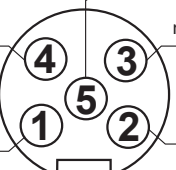
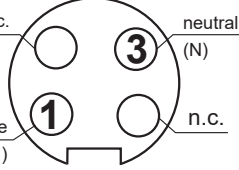
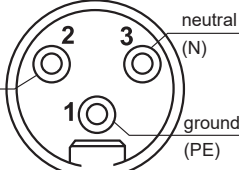
Option	Polycarbonate Enclosure	Stainless Steel Enclosure	Pin Assignment
AM3	 <p>Analogue output</p> <p>Power supply</p> <p>Modbus RTU (only with order code J3)</p>	 <p>Modbus RTU (only with order code J3)</p> <p>Analogue output</p> <p>Power supply 100 - 240 V AC</p>	 <p>GND RS485 (shielded)</p> <p>RS485 A (=D+)</p> <p>RS485 B (=D-)</p> <p>n.c.</p> <p>Modbus RTU Socket</p>
			 <p>GND Output</p> <p>OUT 2</p> <p>OUT 1</p> <p>n.c.</p> <p>Analogue output Plug</p>
			 <p>neutral wire (N)</p> <p>phase (L1)</p> <p>n.c.</p> <p>Power supply 100 - 240 V AC for polycarbonate enclosure Plug</p>
			 <p>neutral wire (N)</p> <p>phase (L1)</p> <p>grounding (PE)</p> <p>Power supply 100 - 240 V AC for stainless steel enclosure Plug</p>

Tab. 4 Various options for electrical connections and wiring

5.2 With Cable Glands

For cabling via the cable glands and direct electrical connection within the enclosure, the assignment of the screw terminals in the lower part of the enclosure is as shown in Fig. 35.

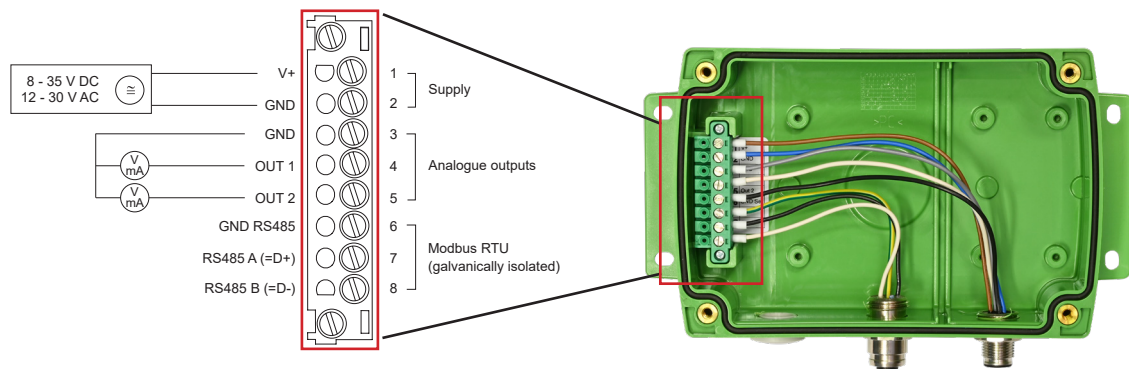
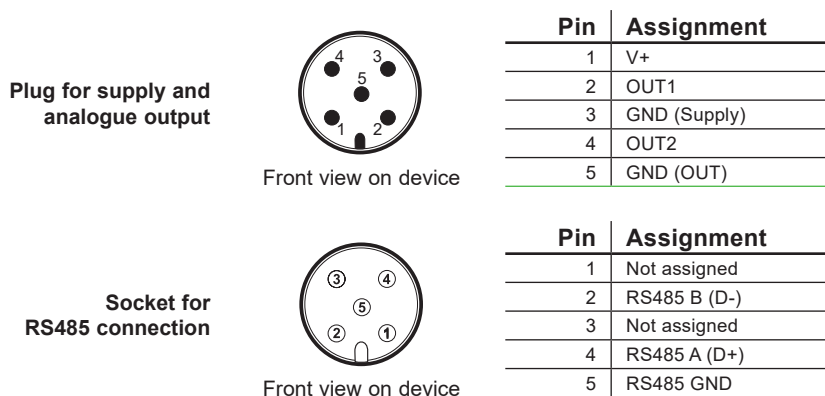

Fig. 35 Pin assignment on screw terminals for electrical connection via cable glands

5.3 Plug Options



i PLEASE NOTE

The cable(s) should be connected according to the number stamped in the plug as shown in the above drawings.

5.4 ARC Module (Option AM1)

Please refer to chapter 3.5.3. ARC Module (Option AM1).

5.5 Alarm Module (Option AM2)

⚠ WARNING

If the stainless steel enclosure is equipped with an alarm module (option AM2) or an integrated power supply 100 - 240 V AC (option AM3) and installation is not carried out correctly, there is the danger of a touch voltage.

The HTS801's stainless steel enclosure must therefore be grounded during operation.

For the contact scheme in standard and inverted operation mode, please refer to Tab. 4 in chapter 5.1 Electrical Connection and Wiring Overview.

5.6 Integrated Power Supply 100 - 240 V AC (Option AM3)

⚠ WARNING

If the stainless steel enclosure is equipped with an alarm module (option AM2) or an integrated power supply 100 - 240 V AC (option AM3) and installation is not carried out correctly, there is the danger of a touch voltage.

The HTS801's stainless steel enclosure must therefore be grounded during operation.

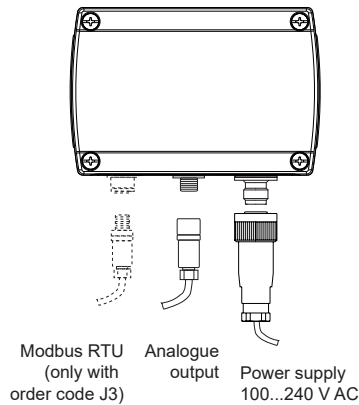

Fig. 36 Polycarbonate enclosure

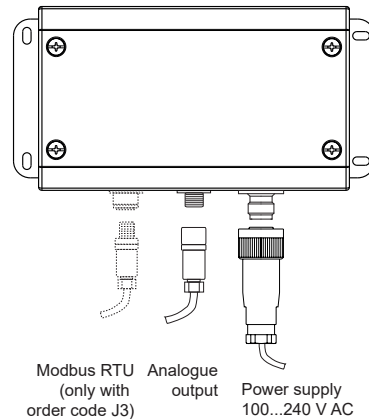

Fig. 37 Stainless steel enclosure

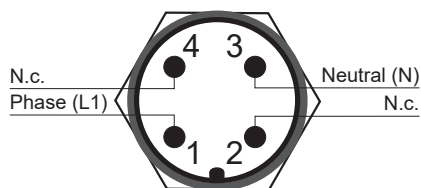

Fig. 38 Plug for power supply 100 - 240 V AC on polycarbonate enclosure

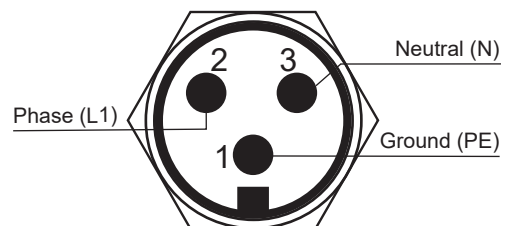

Fig. 39 Plug for power supply 100 - 240 V AC on stainless steel enclosure

⚠ WARNING

Non-compliance to the following instructions can cause an electric stroke with the risk of serious injury or death.

- The AM3 option includes a 1.25 A fuse on the 100 - 240 V side. This fuse may not be replaced by the user, only by the E+E after sales service.
- The protection of the supply cable against excess current and short-circuit must be designated to a wire cross section of 0.8 mm² (AWG 18) (6A fuse).
- The metal enclosure must be grounded during operation.
- All national regulations for installation shall be observed!

NOTICE

External diameter of the supply cable for option AM3: 10...12 mm (0.39...0.47").

Maximum wire cross section for AM3 connecting cable: 1.5 mm² (AWG 16) .

External diameter of the cable for Modbus RTU and analogue output female plug: 4...6 mm (0.16...0.24").

Maximal wire cross section for connecting cable: 0.5 mm² (AWG 21).

6 Setup and Configuration

The HTS801 is ready to use and does not require any configuration by the user. The factory setup of HTS801 corresponds to the type number ordered. Please refer to the data sheet at www.epluse.com/hts801. If needed, the user can change the factory setup. This chapter describes the configuration possibilities of PCS10 Product Configuration Software and of the digital RS485 interface with Modbus RTU.

6.1 PCS10 Product Configuration Software

6.1.1. General

The PCS10 provides a convenient graphical user interface to the HTS801 for changing the factory setup via a USB configuration cable (USB-C to USB-A, accessory order code HA010327). If the HTS801 is connected to a PC via the USB interface, power is supplied via USB; an external power supply is not required.

NOTICE

Data integrity might not be provided during firmware download.

Ensure that the device is only powered by the USB interface during firmware update, otherwise the update may fail.

To use the software for adjustments and changes in settings, please proceed as follows:

1. Download the PCS10 Product Configuration Software from www.epluse.com/pcs10 and install it on the PC.
2. Connect the HTS801 to the PC using the USB cable. Refer to Fig. 40 and Fig. 41 below.
3. Start the PCS10 software.
4. Follow the instructions on the PCS10 opening page for scanning the ports and identifying the connected device.
5. Click on the desired setup or adjustment mode from the main PCS10 menu on the left. Follow the online instructions of the PCS10 which are displayed when clicking the "Tutorial" button.
6. Changes are uploaded to the probe by pressing the "Sync" button.



Fig. 40 USB service interface



Fig. 41 Plugged USB cable and LED indication

6.1.2. Analogue Outputs

Both analogue outputs shall be configured to either voltage or current. Measurands, analogue output range and scaling are freely selectable. All settings can be performed using the PCS10 Product Configuration Software or via display and push-buttons.

The analogue outputs feature an error indication function according to NAMUR NE43. In the case of an error the output signal will freeze at 21 mA or 11 V respectively.

i PLEASE NOTE

The error display is disabled by default.

The analogue outputs are both either current or voltage outputs. When changing one of the analogue outputs from current to voltage and vice versa, the second output will change automatically to this output type. The scaling changes automatically if it is out of physical range (i.e. 20 mA will be changed to 10 V instead of 20 V).

i PLEASE NOTE

Check output scale after changing between voltage and current output.

6.1.3. Simulation Mode

For the purpose of testing the measurement system, the RH and T output values can be fixed for a certain time. All calculated humidity related physical quantities are then based on these two arbitrarily set values.

The Simulation Mode can be set up and started with the PCS10 Product Configuration Software or via Modbus commands. The desired RH and T values have to be entered. The duration for which the values are valid has to be specified in seconds.

The Simulation Mode is available for all HTS801 models.

6.1.4. Multipoint Adjustment

For the HTS801, PCS10 offers the option of performing a multi-point adjustment for RH and/or T. The procedure can be used to correct the sensor deviations of the RH and/or T values at several points (min. 2, max. 10). With PCS10, the user enters all reference values and the corresponding deviations of the device to be tested at each individual point. All entered data is taken into account for the correction.

6.1.5. Eventlog and Histograms

HTS801 features RH/T histogram data and eventlog information readable via PCS10 to simplify communication with the E+E Customer Service and to provide additional information on sensor status.

Eventlog

All important events (customer adjustments, detected errors, ARC cycles, ...) that have occurred during the sensor's lifetime are recorded in a permanent memory. The user can export the complete list with PCS10 and send it to the E+E Customer Service.

This data cannot be deleted by the user.

Histogram data

The operating conditions under which the sensor has been used (RH and T for the probe, T for the main unit) are recorded in a permanent memory (since the sensor was first switched on).

Two types of histograms are available:

- Lifetime histogram:
Lists the data since the sensor was first switched on. The lifetime data cannot be deleted by the user.
- Analysis histogram:
Lists the data since the last time the recorded values were reset. A reset can be carried out by the user.

All histogram data can be exported and sent in to the E+E Customer Service to simplify communication.

6.2 RS485 Digital Interface

6.2.1. Modbus RTU Setup

	Factory settings	Selectable values (via PCS10)
Baud rate	9 600	9 600, 19 200, 38 400, 57 600, 76 800
Data bits	8	8
Parity	Even	None, odd, even
Stop bits	1	1, 2
Modbus address	230 (0xE6)	1...247

Tab. 5 Modbus RTU protocol settings

i PLEASE NOTE

- The recommended settings for multiple devices in a Modbus RTU network are 9 600, 8, even, 1.
- The HTS801 represents 1 unit load on an RS485 network.

Device address, baud rate, parity and stop bits can be set via:

- PCS10 Product Configuration Software and the USB configuration cable HA010327.
The PCS10 can be downloaded free of charge from www.epluse.com/pcs10.
- Modbus protocol in the register 1 (0x00) and 2 (0x01).
See Application Note Modbus AN0103 (available at www.epluse.com/hts801).

The serial number as ASCII-code is located in read-only registers 1 - 8 (0x00 - 0x07).

The firmware version is located in read-only register 9 (0x08) (bit 15...8 = major release; bit 7...0 = minor release).

The sensor name as ASCII-code is located in read-only registers 10 - 17 (0x09 - 0x11).

NOTICE

When reading the serial number or the sensor name, it is always necessary to read all registers, even if the desired information requires less.

NOTICE

For obtaining the correct floating point values, both registers have to be read within the same reading cycle. The measured value can change between two Modbus requests, exponent and mantissa may get inconsistent then.

i INFO

The Modbus function codes mentioned throughout this document shall be used as described in the MODBUS APPLICATION PROTOCOL SPECIFICATION V1.1b3, chapter 6:
www.modbus.org/docs/Modbus_Application_Protocol_V1_1b3.pdf

Device settings (INT16)

Parameter	Register number ¹⁾ [Dec]	Register address ²⁾ [Hex]	Size ³⁾
Write register: function code 0x06			
Modbus address ⁴⁾	1	00	1
Modbus protocol settings ⁴⁾	2	01	1
ARC trigger	509	1FC	1

Device information (INT16)

Parameter	Register number ¹⁾ [Dec]	Register address ²⁾ [Hex]	Size ³⁾
Read register: function code 0x03 / 0x04			
Serial number sensor (as ASCII)	1	00	8
Firmware version	9	08	1
Sensor name (as ASCII)	10	09	8
Serial number smart probe (as ASCII)	18	11	8
ARC remaining seconds	510	1FD	1
Device status	609	260	1
Module status	610	261	1
Device operating conditions	611	262	1

1) Register number (decimal) starts from 1.

2) Register address (hexadecimal) starts from 0.

3) Number of registers

4) For Modbus address and protocol settings see Application Note Modbus AN0103 (available at www.epluse.com/hts801).

Tab. 6 HTS801 registers for device setup

For highest accuracy of RH related calculated parameters, the user can set the working pressure at the operating point using the “working pressure” register (5001-5002, 0x1388-0x1389) or PCS10.

The HTS801 features a simulation mode for temperature and relative humidity, please refer to chapter 6.1.3 Simulation Mode.

The user can set the simulated temperature and relative humidity values via PCS10 or using the registers 5902 (0x170D) and 5904 (0x170F). The simulation mode can be started via PCS10 or using the register 5901 (0x170C). For configuration, please refer to Tab. 7 below.

Application parameters

Parameter	Type	Register number ¹⁾ [Dec]	Register address ²⁾ [Hex]	Size ³⁾
Write register: function code 0x10 / read register: function code 0x03/04				
Working pressure	FLOAT32	5001	1388	2
Simulated temperature	FLOAT32	5902	170D	2
Simulated relative humidity	FLOAT32	5904	170F	2
Write register: function code 0x06 / read register: function code 0x03/04				
Simulation duration	UINT16	5901	170C	1

- 1) Register number starts from 1.
 2) Protocol address starts from 0.
 3) Number of registers

Tab. 7 HTS801 application parameters

6.2.2. Modbus Register Map

The measured data is saved as 32 bit floating point values (data type FLOAT32) and as 16 bit signed integer values (data type INT16).

FLOAT32

Measurand	Unit	Register number ¹⁾ [DEC]	Register address ²⁾ [HEX]
Read register: function code 0x03 / 0x04			
Relative humidity	%	1021	3FC
Temperature	°C	1003	3EA
Temperature	°F	1005	3EC
Temperature	K	1009	3F0
Dew point temperature	°C	1105	450
Dew point temperature	°F	1107	452
Dew point temperature	K	1147	47A
Frost point temperature	°C	1131	46A
Frost point temperature	°F	1133	46C
Frost point temperature	K	1149	47C
Absolute humidity	g/m ³	1113	458
Absolute humidity	gr/ft ³	1115	45A
Mixing ratio	g/kg	1121	460
Mixing ratio	gr/lb	1123	462
Wet bulb temperature	°C	1109	454
Wet bulb temperature	°F	1111	456
Wet bulb temperature	K	1145	478
Specific enthalpy	kJ/kg	1125	464
Specific enthalpy	BTU/lb	1129	468
Specific enthalpy	ft lbf/lb	1127	466
Water vapour partial pressure	mbar	1101	44C
Water vapour partial pressure	psi	1103	44E
Ice bulb temperature	°C	1237	4D4
Ice bulb temperature	°F	1239	4D6
Ice bulb temperature	K	1241	4D8
Specific humidity	g/kg	1247	4DE
Specific humidity	gr/lb	1249	4E0

- 1) Register number starts from 1
 2) Register address starts from 0

Tab. 8 HTS801 FLOAT32 measured data registers

INT16

Measurand	Unit	Scale ³⁾	Register number ¹⁾ [DEC]	Register address ²⁾ [HEX]
Read register: function code 0x03 / 0x04				
Relative humidity	%	100	4011	FAA
Temperature	°C	100	4002	FA1
Temperature	°F	50	4003	FA2
Temperature	K	50	4005	FA4
Dew point temperature	°C	100	4053	FD4
Dew point temperature	°F	100	4054	FD5
Dew point temperature	K	100	4074	FE9
Frost point temperature	°C	100	4066	FE1
Frost point temperature	°F	100	4067	FE2
Frost point temperature	K	100	4075	FEA
Absolute humidity	g/m ³	10	4057	FD8
Absolute humidity	gr/ft ³	10	4058	FD9
Mixing ratio	g/kg	10	4061	FDC
Mixing ratio	gr/lb	10	4062	FDD
Wet bulb temperature	°C	100	4055	FD6
Wet bulb temperature	°F	100	4056	FD7
Wet bulb temperature	K	100	4073	FE8
Specific enthalpy	kJ/kg	1	4063	FDE
Specific enthalpy	BTU/lb	1	4064	FDF
Specific enthalpy	ft lbf/lb	1	4065	FE0
Water vapour partial pressure	mbar	10	4051	FD2
Water vapour partial pressure	psi	1000	4052	FD3
Ice bulb temperature	°C	100	4119	1016
Ice bulb temperature	°F	100	4120	1017
Ice bulb temperature	K	50	4121	1018
Specific humidity	g/kg	10	4124	101B
Specific humidity	gr/lb	10	4125	101C

1) Register number starts from 1

2) Register address starts from 0

3) Examples: For scale 100, the reading of 2550 means a value of 25.5. For scale 50, the reading of 2550 means a value of 51.

Tab. 9 HTS801 INT16 measured data registers

6.2.3. Freely Configurable Custom Modbus Map

It is possible to map measured value/status registers arbitrarily in a block with up to 20 registers provided for this purpose. This means that registers of interest may be mapped in an area with consecutive registers, so that important values can be queried with a single command in one block.

The custom map can be configured via:

- PCS10 Product Configuration Software and the USB configuration cable HA010327.
The PCS10 can be downloaded free of charge from www.epluse.com/pcs10.
- Modbus protocol commands, refer to the example in chapter 6.3 Modbus RTU Example.

The register block for the configuration of the customisable Modbus map consists of the registers 6001 (0x1770) to 6010 (0x1779). For the blockwise query of the measured values behind Modbus registers 3001 (0xBB8) to 3020 (0xBCB), the firmware accesses this configuration area and thus gets the information which measured value/status registers are to be output. A maximum of 10 user-defined registers can be mapped. The table below shows an example:

Registers with these assigned measurands map to registers mirrored from source registers	
Dec	Hex	Meas.	Unit	Type	Dec	Hex	Dec	Hex
<i>Function code 0x10</i>					<i>Function code 0x03/0x04</i>			
6001	0x1770	RH	%	FLOAT32	3001	0xBB8	1021	0x3FC
				FLOAT32	3002	0xBB9	1022	0x3FD
6002	0x1771	T	°C	FLOAT32	3003	0xBBA	1003	0x3EA
				FLOAT32	3004	0xBBB	1004	0x3EB
6003	0x1772	Td	°C	FLOAT32	3005	0BBC	1105	0x450
				FLOAT32	3006	0BBD	1106	0x451
6004	0x1773	Tw	°C	FLOAT32	3007	0BBE	1109	0x454
				FLOAT32	3008	0BBF	1110	0x455
6005	0x1774	T	°F	FLOAT32	3009	0xBC0	1005	0x3EC
				FLOAT32	3010	0xBC1	1006	0x3ED
6006	0x1775	Td	°F	FLOAT32	3011	0xBC2	1107	0x452
				FLOAT32	3012	0xBC3	1108	0x453
6007	0x1776	RH	%	INT16	3013	0xBC4	4011	0xFAA
6008	0x1777	T	°C	INT16	3014	0xBC5	4002	0xFA1
6009	0x1778	T	°F	INT16	3015	0xBC6	4003	0xFA2
					3016	0xBC7	65536	0xFFFF
					3017	0xBC8	65536	0xFFFF
					3018	0xBC9	65536	0xFFFF
					3019	0xBCA	65536	0xFFFF
					3020	0xBCB	65536	0xFFFF

Tab. 10 Custom Modbus map example

6.2.4. Device Status Indication

If a critical error occurs, all Modbus values are set to NaN (according to IEEE754 for data type FLOAT32) or to 0x8000 (INT16). It is possible to read out all status and error information via Modbus register 609 (0x260). Errors are displayed in bit-coded form. If an event is present, the corresponding bit is set to 1.

Measured values outside the measuring range are limited with the corresponding limit value.

Error Bits	Description	Recommended action
Bit 0	RH sensor shortcut	Return the unit to the E+E Customer Service
Bit 1	RH sensor broken	Return the unit to the E+E Customer Service
Bit 2	T sensor shortcut	Return the unit to the E+E Customer Service
Bit 3	T sensor broken	Return the unit to the E+E Customer Service
Bit 4	PT1000 sensor shortcut (T17 and T28 only)	Return the unit to the E+E Customer Service
Bit 5	PT1000 sensor broken (T17 and T28 only)	Return the unit to the E+E Customer Service
Bit 6	Tube heater failure	Return the unit to the E+E Customer Service
Bit 7	RH sensor contamination (little bit)	Clean the RH sensing element
Bit 8	RH sensor contamination (dirty)	Clean the RH sensing element
Bit 9	RH sensor contamination (very dirty)	Return the unit to the E+E Customer Service
Bit 10	Parallel capacity misconfiguration	Return the unit to the E+E Customer Service
Bit 11	Analogue voltage output 1 shortcut	Check wiring
Bit 12	Analogue voltage output 2 shortcut	Check wiring
Bit 13	Analogue current output 1 open loop	Check wiring
Bit 14	Analogue current output 2 open loop	Check wiring
Bit 15	-	-

Tab. 11 Device status indication

6.2.5. Module Status Indication

If a critical error occurs, all Modbus values are set to NaN (according to IEEE754 for data type FLOAT32) or to 0x8000 (INT16). It is possible to read out the module status information via Modbus register 610 (0x261). Status indication is bit-coded. If an event is present, the corresponding bit is set to 1.

Measured values outside the measuring range are limited with the corresponding limit value.

Error Bits	Description	Recommended action
Bit 0	Display communication error	Return the unit to the E+E Customer Service
Bit 1	Ext. module communication error (AM1, AM2, J4)	Return the unit to the E+E Customer Service
Bit 2	-	-
Bit 3	-	-
Bit 4	-	-
Bit 5	-	-
Bit 6	-	-
Bit 7	-	-
Bit 8	ARC active	None
Bit 9	CG active	None
Bit 10	-	-
Bit 11	-	-
Bit 12	-	-
Bit 13	-	-
Bit 14	-	-
Bit 15	-	-

Tab. 12 Module status indication

6.2.6. Device Operating Conditions Indication

If a critical error occurs, all Modbus values are set to NaN (according to IEEE754 for data type FLOAT32) or to 0x8000 (INT16). It is possible to retrieve device operating conditions information from Modbus register 611 (0x262). Errors are displayed in bit-coded form. If an event is present, the corresponding bit is set to 1.

Measured values outside the measuring range are limited with the corresponding limit value.

Event Bits	Description	Recommended action
Bit 0	PCB temperature too low	Check temperature at installation point
Bit 1	PCB temperature too high	Check temperature at installation point
Bit 2	T value too low	Check process temperature
Bit 3	T value too high	Check process temperature
Bit 4	PT1000 value too low (T17 and T28 only)	Check process temperature
Bit 5	PT1000 value too high (T17 and T28 only)	Check process temperature
Bit 6	RH sensor too dry	Check process humidity
Bit 7	RH sensor condensation	Check process humidity
Bit 8	-	-
Bit 9	-	-
Bit 10	-	-
Bit 11	-	-
Bit 12	-	-
Bit 13	-	-
Bit 14	-	-
Bit 15	-	-

Tab. 13 Device operating conditions indication

6.2.7. Retrofit with RS485 Module

HTS801 can be retrofitted with an RS485 module. Before retrofitting, please make sure that the device firmware is updated to the latest version by using PCS10. Please observe the instructions in the quick guide of the retrofit module.

The RS485 module is automatically detected by HTS801 at power on. Module setup can be performed via PCS10 Product Configuration Software or via display and push-buttons.

The module is available as an accessory (please refer to chapter 8 Spare Parts / Accessories).

6.3 Modbus RTU Example

The HTS801's Modbus address is 230 [0xE6].

Please refer to

- MODBUS APPLICATION PROTOCOL SPECIFICATION V1.1b3, chapter 6: www.modbus.org/docs/Modbus_Application_Protocol_V1_1b3.pdf
- E+E Application Note Modbus AN0103 (available at www.epluse.com/hts801)

Read the temperature (FLOAT32) T = 25.6787014007568359375 °C from register address 0x3EA:

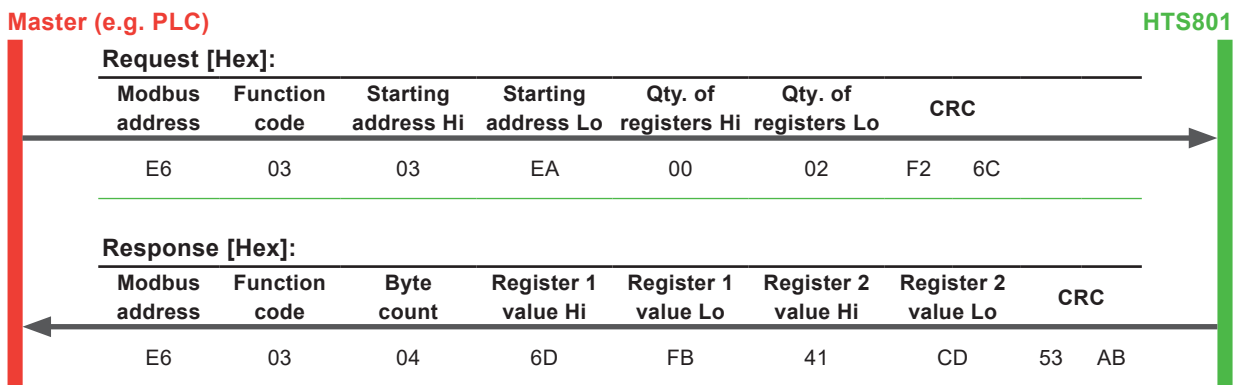

Tab. 14 Example temperature query

Decoding of floating point values:

Floating point values are stored according to IEEE754. The byte pairs 1, 2 and 3, 4 are transformed as follows (numbers taken from T reading Modbus request/response example above):

Modbus response [Hex]			
Register 1 Hi	Register 1 Lo	Register 2 Hi	Register 2 Lo
6D	FB	41	CD
MMMMMMMM	MMMMMMMM	SEEEEEEE	EMMMMMMM

Tab. 15 Modbus response

IEEE754			
Register 2 Hi	Register 2 Lo	Register 1 Hi	Register 1 Lo
41	CD	6D	FB
0100 0001	1100 1101	0110 1101	1111 1011
SEEE EEEE	EMMM MMMM	MMMM MMMM	MMMM MMMM
Decimal value: 25.6787014007568359375			

Tab. 16 Data representation according to IEEE754

7 Maintenance and Service

7.1 Self Diagnosis and Error Messages

7.1.1. Error Messages on the Display

Error Description	Error Code (Display)	Error Category	Recommended Action
Voltage out short circuit - output 1 only*	1.x	1	Check the wiring of the outputs
Current loop open - output 1 only	2.x		Check the wiring of the outputs
RH sensor polluted	3.x		Clean the sensor
Hardware error	5.x	2	Return the faulty unit to E+E for service
	6.x		
	8.x		
Temperature measurement failure	7.x		
Humidity measurement failure	9.x		
	10.x		

For all other error codes occurring on the display, please contact the E+E service team.

* not available with 0 - 1 V output

Tab. 17 Overview of error codes

Error Category	Description
1	<p>Non-critical error, can be solved by the user.</p> <ul style="list-style-type: none"> The display blinks and the buzzer beeps every 10 seconds. The red status LED lights continuously.
2	<p>Critical error, return the device to E+E for service.</p> <ul style="list-style-type: none"> The display blinks and the buzzer beeps continuously. The red status LED flashes.

Tab. 18 Explanation of the error category

7.1.2. Status and Error Messages via LEDs

Four status LEDs placed on both sides of the PCB next to the USB service interface. The USB connector is accessible after removing the blind cover.

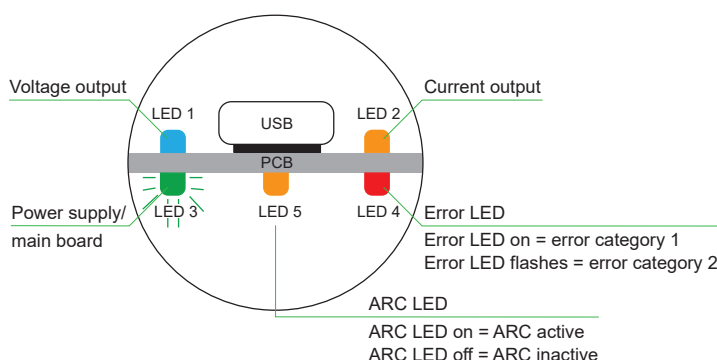

Fig. 42 Status LEDs

LED (colour)	Description
1 (blue)	Analogue output one set to voltage.
2 (orange)	Analogue output one set to current.
3 (flashing green)	Supply voltage applied (microprocessor is active).
4 (red) permanently lit flashes	Error category 1 Error category 2
5 (orange)	ARC status

Tab. 19 Explanation of the LED colors

7.2 Cleaning the Sensing Head and Filter Cap Replacement

In case of dusty, oily and polluted environment

- The filter cap shall be replaced once in a while with an E+E original one. A polluted filter cap causes longer response time of the device.
- If needed, the sensing head can be cleaned. For cleaning instructions please see www.epluse.com/hts801.

7.3 Automatic ReCOVERY (ARC)

When capacitive humidity sensors are exposed to chemical pollution (e.g. detergent residue), the presence of foreign molecules can distort the measurement reading.

The foreign molecules can be evaporated by heating the measurement cell briefly and intensively. Reconditioning helps to minimize distorted measurement readings during the calibration interval.

It is recommended to heat the measurement cell manually after the cleaning or sterilization process or if distorted measurement readings are suspected. Trigger the ARC-module with the external signal (see chapter 3.5.3. ARC Module (Option AM1)).

i PLEASE NOTE

Before a recalibration is done after an ARC cycle, reconditioning of the sensing element is recommended. For best reconditioning, please allow 2 free calibration cycles between 15 %RH and 90 %RH in steps of ~20 %RH and 20 min stabilisation time.

7.4 RH and T Calibration and Adjustment

Humidity calibration and adjustment

Depending on the application and the requirements of certain industries, there might arise the need for periodical humidity calibration (comparison with a reference) or adjustment (bringing the device in line with a reference).

Calibration and adjustment at E+E Elektronik

Calibration and/or adjustment can be performed in the E+E Elektronik calibration laboratory. For information on the E+E capabilities in ISO or accredited calibration please see www.eplusecal.com.

Calibration and adjustment by the user

Depending on the level of accuracy required, the humidity reference can be:

- Humidity Calibrator (e.g. Humor 20), please see www.epluse.com/humor20.
- Handheld Device (e.g. Omniport30), please see www.epluse.com/omniport30.
- Humidity Calibration Kit (e.g. E+E Humidity Standards), please see www.epluse.com/hts801.

Perform offset or 2-point adjustment via display and push-buttons or via PCS10 Product Configuration Software (see below).

Additionally, the HTS801 can be adjusted in multiple points (min. 2, max. 10) for RH and T using PCS10. Please refer to chapter 6.1.4. Multipoint Adjustment.

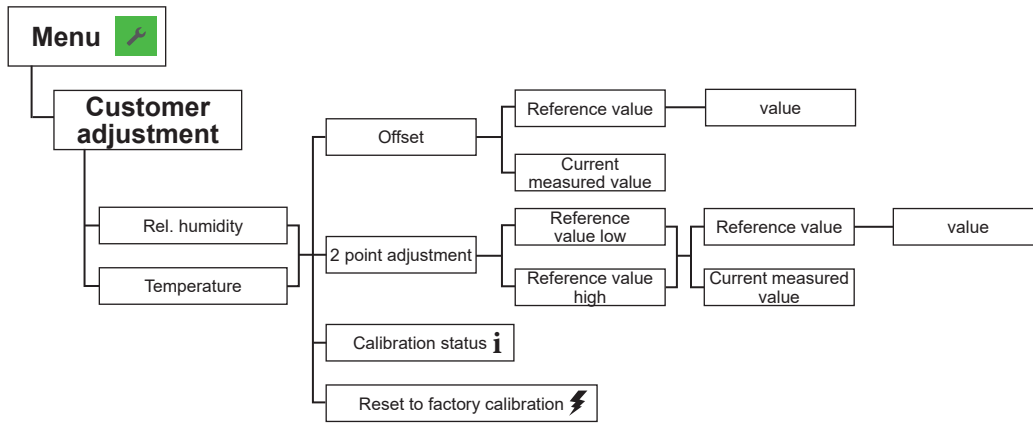

Fig. 43 Customer adjustment menu

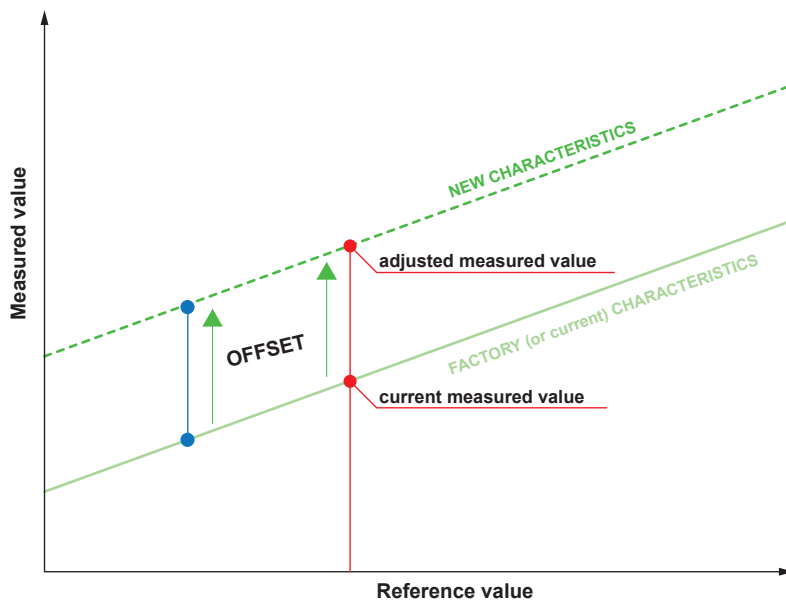

Fig. 44 1-point adjustment adjustment (offset)

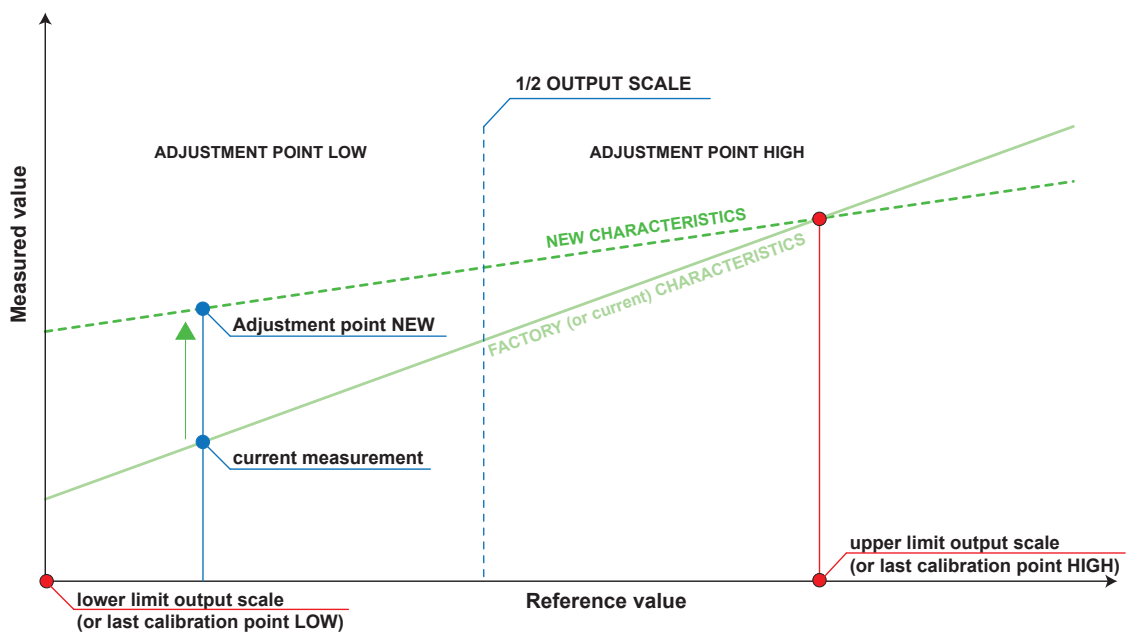

Fig. 45 2-point adjustment procedure

7.4.1. RH and T Adjustment and Calibration for Types T5 / T9 / T10

i PLEASE NOTE

Before adjusting or calibrating an HTS801 with CG option (types T5 / T9 / T10), the CG function must be deactivated. Otherwise, the heating may start during adjustment/calibration and the outputs may freeze.

The CG function can be deactivated either via PCS10 or the optional display.

i PLEASE NOTE

Remember to reactivate the CG function after adjustment/calibration to ensure proper functioning of the unit.

7.4.2. RH and T Adjustment and Calibration for Type T7

The HTS801 with probe type T7 has a dual heating system in a single probe design to prevent both: condensation on the RH sensing element and on the probe body through a regulated heating strategy. This results in a very short response time and allows accurate measurement of the dew point temperature Td.

i PLEASE NOTE

Before adjusting or calibrating an HTS801 with remote type T7, the probe heating must be deactivated. Otherwise, the probe heating will affect the stability of the adjustment/calibration.

The probe heating can be deactivated either via PCS10 or the optional display.

i PLEASE NOTE

RH adjustment/ calibration of an HTS801 with remote sensor T7 is only possible up to a maximum value of 70 %RH. This is due to the controlled heating strategy.

i PLEASE NOTE

Remember to reactivate the probe heating after adjustment/calibration to ensure proper functioning of the unit.

7.4.3. RH and T Adjustment and Calibration for Types T17 / T28

The HTS801 with T17 / T28 probes has a dual heating system with two probes to prevent condensation on both the RH sensing element and the probe body through a controlled heating strategy. This results in a very short response time and fast recovery after condensation. In addition, it enables accurate measurement of relative humidity even in continuously high humidity and condensing conditions.

i PLEASE NOTE

Before adjusting or calibrating an HTS801 with remote type T17 / T28, the probe heating must be deactivated. Otherwise, the probe heating will affect the stability of the adjustment / calibration.

The probe heating can be deactivated either via PCS10 or the optional display.

i PLEASE NOTE

When RH adjusting / calibrating an HTS801 with remote probe T17 / T28, it is of utmost importance to keep the RH and T probes at the same temperature. This can be achieved for example with the Humor 20 adapter for T17 models HA020401. Please refer to Humor20 for further details.

i PLEASE NOTE

The best adjustment results are achieved when a T adjustment is made first, followed by an RH adjustment.

i PLEASE NOTE

Remember to reactivate the probe heating after adjustment / calibration to ensure proper functioning of the unit.

7.5 Fuse Replacement for Integrated Power Supply 100 - 240 V AC (Option AM3)

WARNING

The AM3 option includes a 1.25 A fuse on the 100 - 240 V side. This fuse may not be replaced by the user, only by the E+E after sales service.

The protection of the supply cable against excess current and short-circuit must be designated to a wire cross section of 0.8 mm² (AWG 18) (6A fuse).

WARNING

There is the risk of electric stroke and subsequent serious injury or death.

- The metal enclosure must be grounded during operation.
- All national regulations for installation shall be observed!

8 Spare Parts / Accessories

For further information please refer to the [Accessories](#) datasheet.

Description	Code
E+E Product Configuration Software (Free download: www.epluse.com/pcs10)	PCS10
Stainless steel mounting flange Ø12 mm (0.47")	HA010201
Stainless steel mounting flange for Ø6 mm (0.24") T probe	HA010207
Stainless steel wall mounting clip Ø12 mm (0.47")	HA010225
Pressure-tight feedthrough For probe assembly up to 20 bar (300 psi)	HA011102 HA011103 HA011104 HA011105
	G1/2" ISO Ø12 mm 1/2" NPT Ø12 mm G1/2" ISO Ø6 mm 1/2" NPT Ø6 mm
Humidity calibration kit	see Humidity Calibration Kit data sheet
Conduit adapter M16x1.5 to NPT 1/2"	HA011101
Drip water protection	HA010503
Radiation shield with artificial ventilation for HTS801-M1T28	HA010508
Radiation shield for RH probe	HA010502
Radiation shield for T probe	HA010506
Mounting set for mast with Ø34 - 54 mm (1.3 - 2.1")	HA010230
Bracket for DIN rail mounting¹⁾	HA010203
Wall Mounting Clip Ø12 mm (0.47")	HA010211
Immersion well, stainless steel Ø6x135 mm (0.25 x 5.4")	HA400202 HA400212
	1/2" ISO 1/2" NPT
RS485 kit for retrofitting	HA010605
Ethernet module for retrofitting, polycarbonate enclosure only	HA010606

1) For polycarbonate enclosure only. Two pieces are necessary for each HTS801

Ordering Guide HTS801 rapidX Smart Probe (PC7 option only)

Feature	Description	Code		
		HTS801P-		
Type	Remote probe up to 180 °C (356 °F)	T5		
	Remote probe, pressure-tight up to 20 bar (300 psi) and 180 °C (356 °F)		T10	
	RH remote probe, pressure-tight up to 20 bar (300 psi) and 180 °C (356 °F)			T17
Filter	Stainless steel sintered	F4	F4	
	PTFE (Polytetrafluoroethylene)	F5	F5	F5
	Stainless steel grid, stainless steel body (180 °C / 356 °F)	F9	F9	F9
	PTFE membrane, stainless steel body			F11
Probe cable length	2 m (6.6 ft)	K2	K2	K2
	5 m (16.4 ft)	K5	K5	K5
	10 m (32.8 ft)	K10	K10	K10
Probe length	65 mm (2.56")	L65		L65
	80 mm (3.15")		L80	
	200 mm (7.87")	L200	L200	L200
	400 mm (15.75")	L400	L400	L400
Process connection	G1/2" ISO - sliding fitting, Ø13 mm (0.51")		PA23	
	1/2" NPT - sliding fitting, Ø13 mm (0.51")		PA25	
Sensing element protection	Without, for very low temperature applications only -70 °C...-40 °C (-94 °F...-40 °F)		C0	
	E+E proprietary coating		C1	

9 Technical Data

Measurands

Relative Humidity (RH)

Measuring range	0...100 %RH
Accuracy ¹⁾ incl. hysteresis, non-linearity and repeatability -15...+40 °C (5...104 °F) RH ≤90 % -15...+40 °C (5...104 °F) RH >90 % -25...+70 °C (-13...+158 °F) -40...+180 °C (-40...+356 °F) -70... -40°C (-94...-40 °F)	±(0.95 + 0.0013 * mv) %RH ±1.8 %RH ±(1.05 + 0.0084 * mv) %RH ±(1.15 + 0.013 * mv) %RH ±3.85 %RH mv = measured value
Factory calibration uncertainty ²⁾ 0...90 %RH 90...100 %RH	±(0.7 + 0.003 * mv) %RH ±1 %RH mv = measured value
Temperature dependence of electronics, typ.	±0.01 % RH / °C (0.0056 %RH / °F)
Response time t ₉₀ with metal grid filter at 20 °C (68 °F)	<15 s

1) Defined against E+E calibration reference.

2) Defined at 23 °C with an enhancement factor k=2, corresponding to a confidence level of 95 %.

Temperature (T)

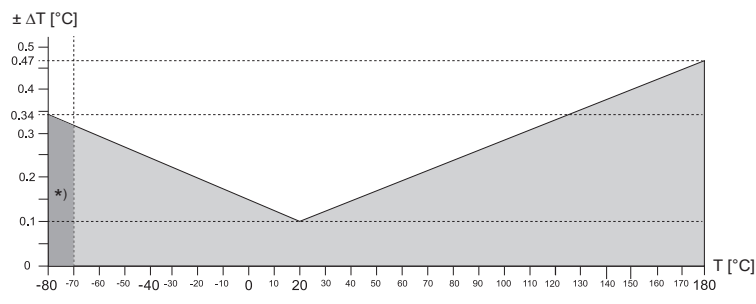
Measuring range probe Types T5 / T7 / T9 / T10 Type T17 Type T28	-70...+180 °C (-94...+356 °F) -80...+180 °C (-112...+356 °F) -80...+60 °C (-112...+140 °F)
Accuracy¹⁾	± ΔT [°C]  <p>*) T17 / T28 T measurement down to -80 °C (-112 °F), RH measurement down to -70 °C (-94 °F)</p>
Factory calibration uncertainty²⁾ @ 23 °C (73 °F)	±0.05 °C
Temperature dependency of electronics, typ.	±0.001 °C / °C

1) Defined against E+E calibration reference.
 2) Defined at 23 °C with an enhancement factor k=2, corresponding to a confidence level of 95 %.

Calculated Physical Quantities

	from	up to		unit
		HTS801-xT5/T9/T10/T17	HTS801-xT7	
Dew point temperature Td	-80 (-112)	100 (212)	100 (212)	°C (°F)
Frost point temperature¹⁾ Tf	-80 (-112)	0 (32)	0 (32)	°C (°F)
Wet bulb temperature Tw	-5 (23)	100 (212)	–	°C (°F)
Water vapour partial pressure e	0 (0)	1100 (15)	–	mbar (psi)
Mixing ratio r	0 (0)	999 (9999)	–	g/kg (gr/lb)
Absolute humidity dv	0 (0)	700 (300)	–	g/m ³ (gr/ft ³)
Specific enthalpy h	0 (0)	2800 (1250)	–	kJ/kg (BTU/lb)

1) Equals Td above 0 °C (32 °F)

Outputs

Analogue



Two freely selectable and scalable analogue outputs	0 - 1 / 5 / 10 V 0 - 20 mA / 4 - 20 mA (3-wire) Both outputs have the same electrical quantity (U, I)	-1 mA < I _L < 1 mA R _L < 500 Ω	I _L = load current R _L = load resistance
Accuracy @23 °C (68 °F)	±0.05 % FS FS = full scale (20 mA, 10 V)		
Temperature dependency¹⁾	±0.005 % FS / °C FS = full scale (20 mA, 10 V)		
Two alarm outputs with option AM2 ²⁾	2x changeover contact 250 V AC / 6 A 28 V DC / 6 A Measurand, threshold and hysteresis configurable via PCS10 or display and push-buttons		

1) Deviating from 23 °C (68 °F), defined at 12 mA or 5 V, respectively
 2) Appropriate for outdoor use, wet location, degree of pollution 2, overvoltage category II, altitude up to 3 000 m (9 843 ft)

Digital

Digital interface Protocol Factory settings Supported Baud rates	RS485 (HTS801 = 1 unit load) Modbus RTU 9 600 Baud, parity even, 1 stop bit, Modbus address 230 9 600, 19 200, 38 400, 57 600 and 76 800
Digital interface Protocol Factory settings	Ethernet-PoE Modbus TCP IP address 192.168.0.64 (static)

General

Power supply class III  USA & Canada: Class 2 supply necessary, max. voltage 30 V DC	8 - 35 V DC 12 - 30 V AC 100 - 240 V AC, 50/60 Hz with option AM3 ¹⁾ PoE with option J4
Current consumption , (typ.) @ 24 V DC / AC 2 voltage outputs 2 current outputs additionally for display additionally for Ethernet	40 mA / 80 mA _{rms} 80 mA / 160 mA _{rms} 50 mA / 150 mA _{rms} 30 mA / 90 mA _{rms}
Electrical connection	Screw terminals max. 1.5 mm ² (AWG 16)
Cable glands for polycarbonate enclosure for metal enclosure	M16x1.5, for cable Ø3...7 mm (0.12...0.28") M16x1.5, for cable Ø4.5...10 mm (0.18...0.39")
Pressure range for pressure-tight probe Type T7 / T10 / T17 Type T9	0.01...20 bar (0.15...300 psi) 0.01...300 bar (0.15...4 350 psi)
Temperature range electronics board operation and storage	-40...60 °C (-40...140 °F) without display -20...50 °C (-4...122 °F) with display
Probe body Material Protection rating	Stainless steel 1.4404 / AISI 316L IP65
Enclosure Material Protection rating	Polycarbonate, UL94 V-0 approved or Stainless steel 1.4404 / AISI 316 L IP65 / NEMA 4X
Electromagnetic compatibility	EN 61326-1 EN 61326-2-3 Industrial Environment FCC Part15 ClassA ICES-003 ClassA
Conformity	 
Configuration Software Interface	PCS10 Product Configuration Software (free download) USB-C, configuration cable HA010327

1) Appropriate for outdoor use, wet location, degree of pollution 2, overvoltage category II, altitude up to 3 000 m (9 843 ft)

Accuracy of E+E Humidity and Temperature Sensors

The measurement accuracy depends both on the performance of the measuring instrument and on the correct installation in the application.

For best accuracy, every E+E RH and T sensor is multipoint factory adjusted and calibrated in a highly stable RH / T reactor. Using a high-precision dew point mirror as reference, the overall uncertainty of the factory calibration U_{cal} is minimal.

The total measurement uncertainty U_{total} for E+E sensors is calculated in accordance with EA-4/02 (European Accreditation, Evaluation of the Measurement Uncertainty in Calibration) and with GUM (Guide to the Expression of Uncertainty in Measurement) as follows:

$$U_{total} = k \cdot \sqrt{\left(\frac{U_{cal}}{2}\right)^2 + \left(\frac{u_{accuracy}}{\sqrt{3}}\right)^2}$$

U_{total} total accuracy incl. factory calibration

U_{cal} the uncertainty of the factory calibration

$u_{accuracy}$ the accuracy of the measurement device

k enhancement factor $k=2$, corresponding to a confidence level of 95 %.

For external calibrations, U_{total} is to be used as the evaluation criterion. The calculation does not include effects due to long-term drift or chemical exposure.

As designated laboratory (NMI) responsible for maintaining the National Standard for humidity and temperature in Austria, E+E Elektronik represents the highest instance in humidity and temperature calibration.

10 Conformity

10.1 Declarations of Conformity

E+E Elektronik Ges.m.b.H. hereby declares that the product complies with the respective regulations listed below:



European directives and standards.

and



UK statutory instruments and designated standards.

Please refer to the product page at www.epluse.com/hts801 for the Declarations of Conformity.

10.2 FCC Part 15 Compliance Statement

This equipment has been tested and found to comply with the limits for a Class A digital device, pursuant to part 15 of the FCC Rules. These limits are designed to provide reasonable protection against harmful interference when the equipment is operated in a commercial environment. This equipment generates, uses, and can radiate radio frequency energy and, if not installed and used in accordance with the instruction manual, may cause harmful interference to radio communications. Operation of this equipment in a residential area is likely to cause harmful interference in which case the user will be required to correct the interference at his own expense.

10.3 ICES-003 Compliance Statement

This Class A digital apparatus complies with Canadian ICES-003.

Cet appareil numérique de la classe A est conforme à la norme NMB-003 du Canada.

11 Appendix: Display Menu Structure

11.1 Overview

Menu 	
Data logging	Configuration of the data logger/graph - sampling rate graphs
Display settings	Display layout - measurands brightness display alarm orientation
Analog output	Output configuration - mode measurands scaling error indication
Heating mode settings	ARC and CG configuration - activation deactivation parameters
Alarm output*	Relay configuration - mode set points state
Customer adjustment	Adjustment - 1 and 2 point humidity/temperature adjustment reset to factory adjustment calibration status
Modbus settings*	Configuration of Modbus RTU data transmission
IP settings*	Configuration of Ethernet module
Device settings	Settings - language date, time parameters password protection
Status	Status and device information

* Menu only available with the corresponding optional module.

Fig. 46 Menu overview

11.2 Detailed Information

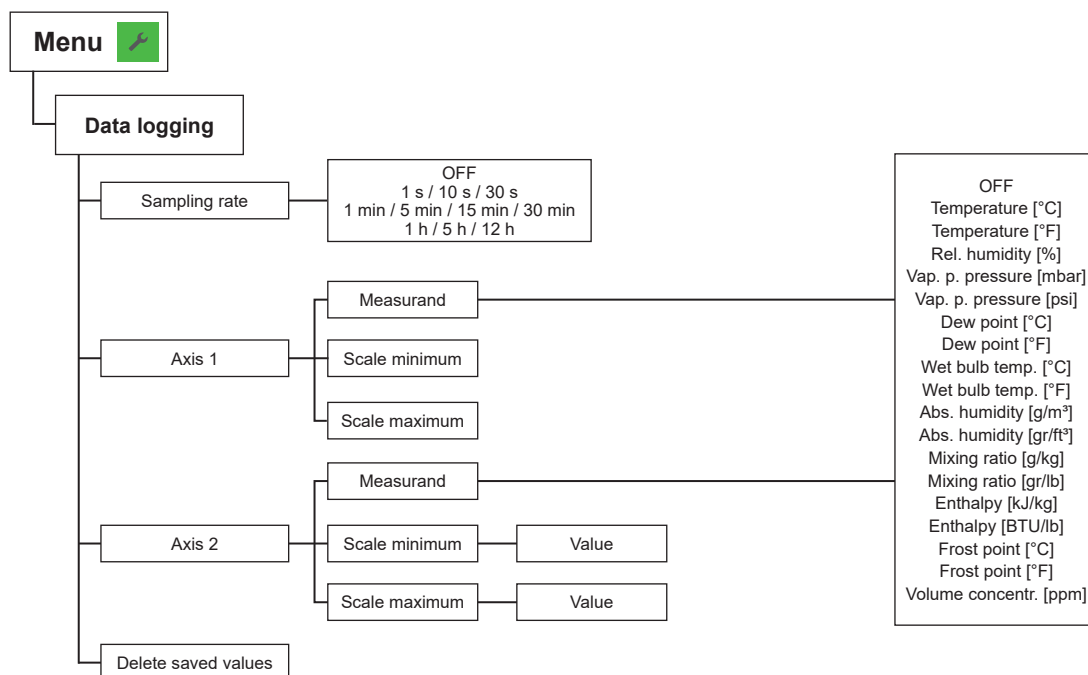

Fig. 47 Data logging

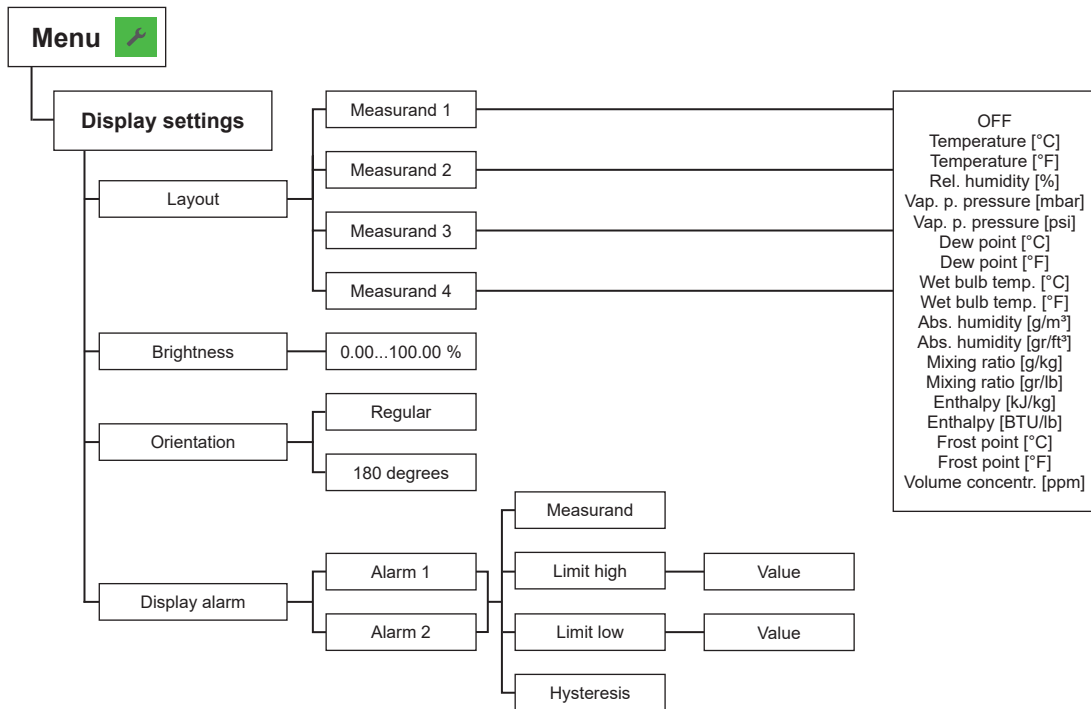

Fig. 48 Display settings

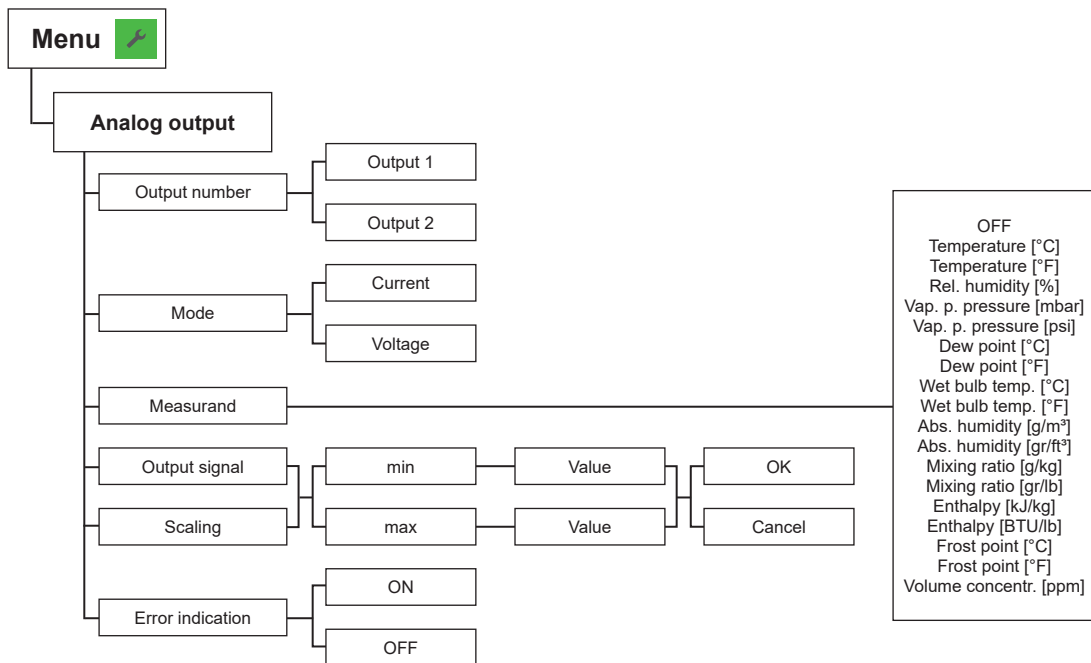

Fig. 49 Analogue output

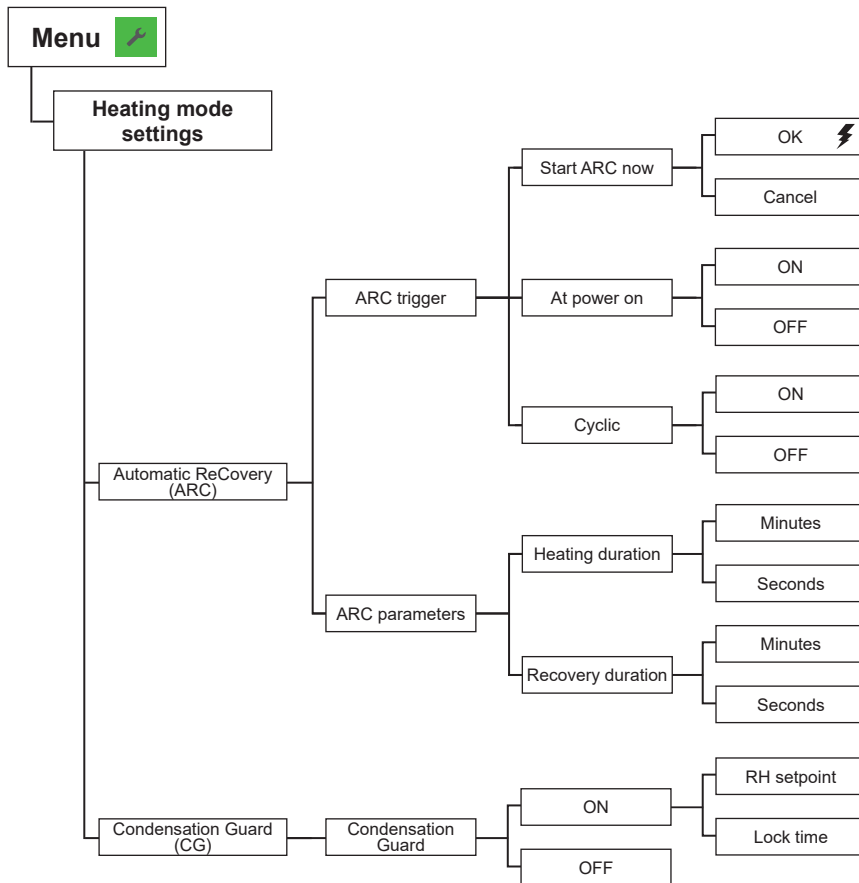

Fig. 50 Heating mode settings

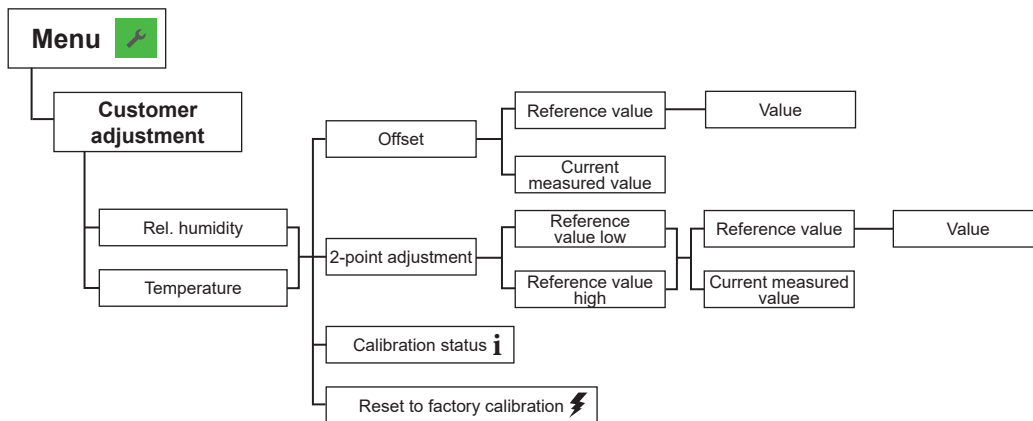

Fig. 51 Customer adjustment

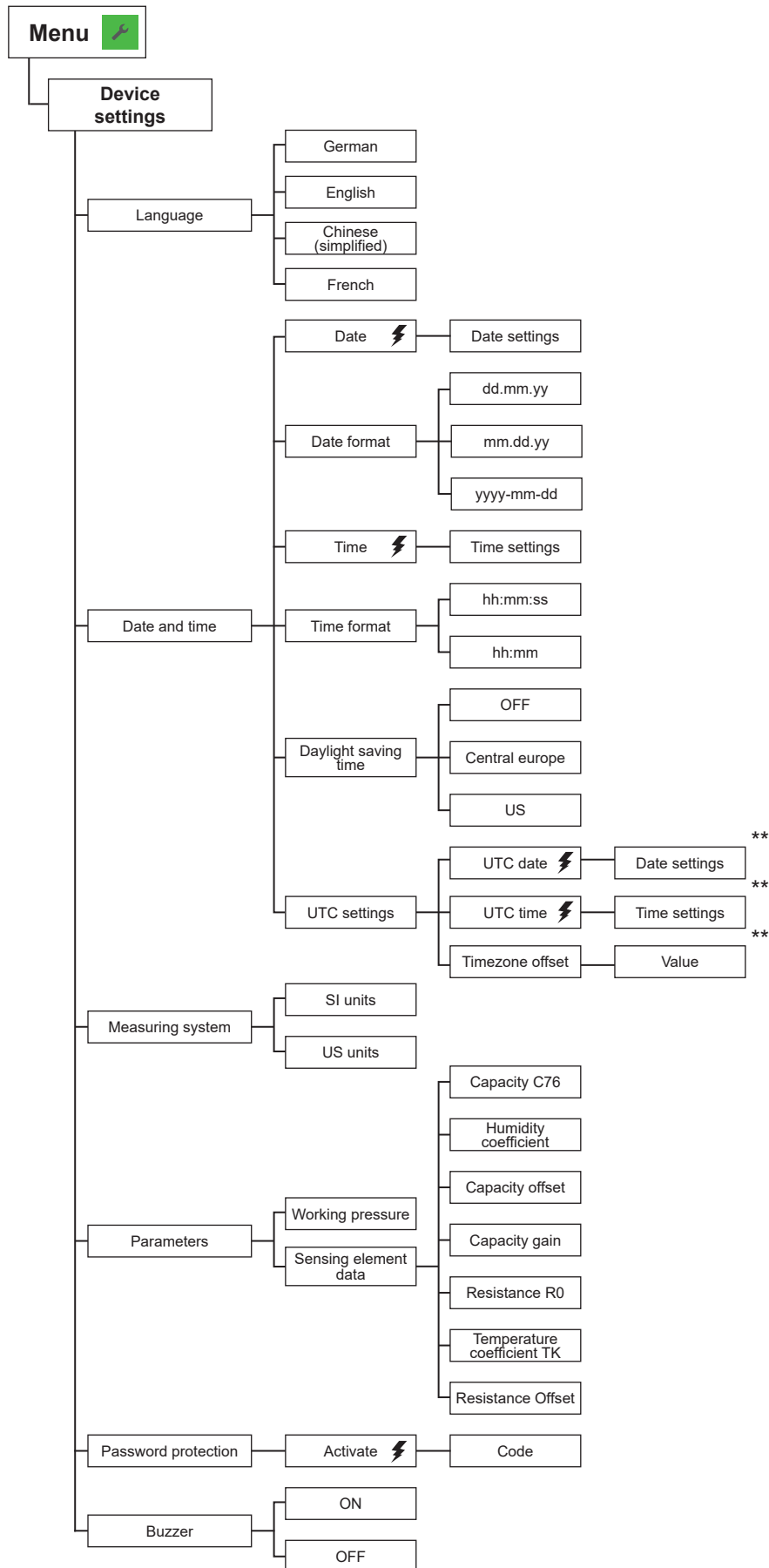

Fig. 52 Device settings

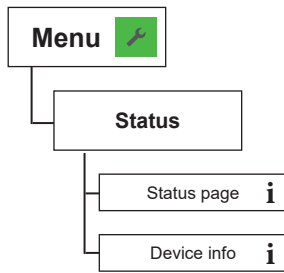
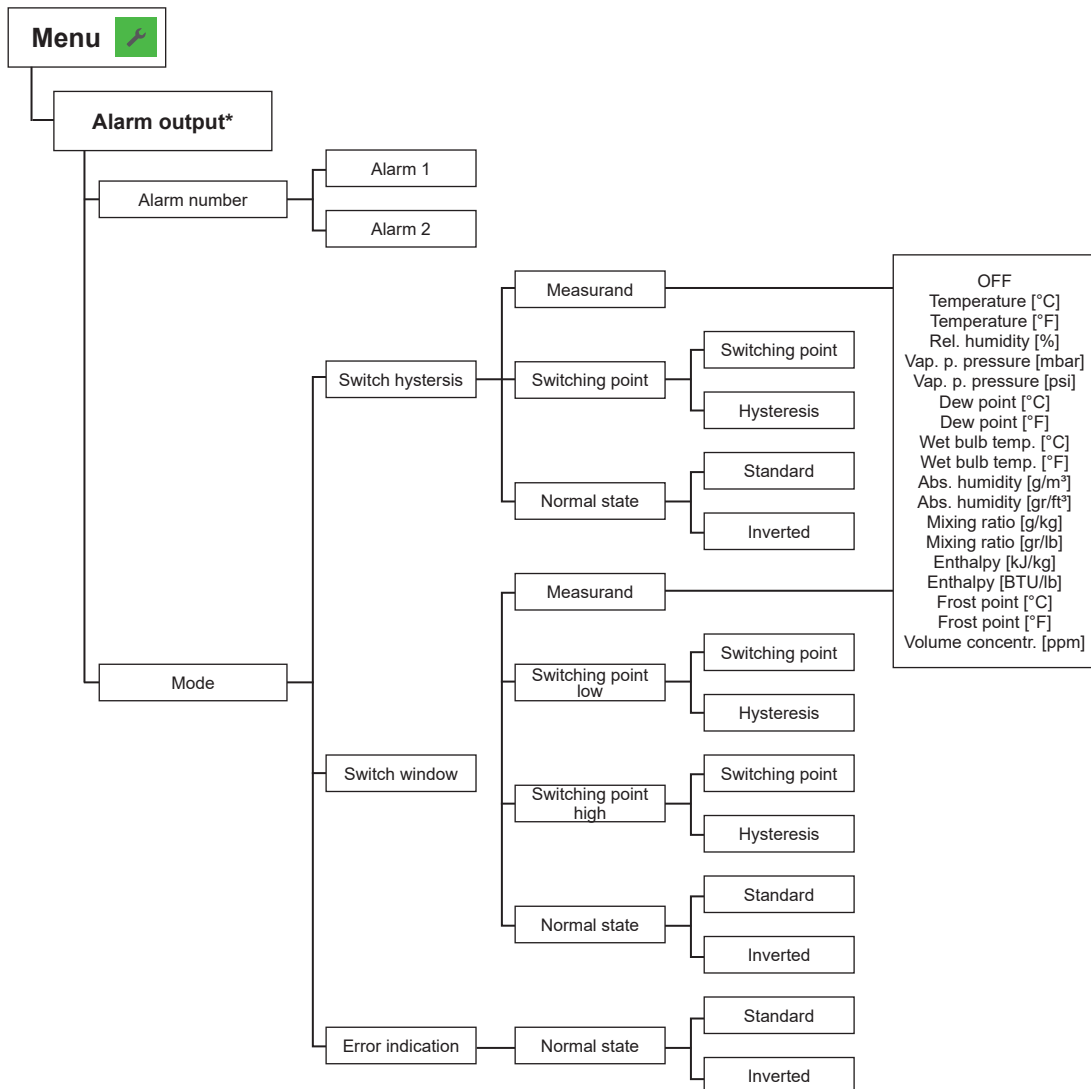

Fig. 53 Status

11.3 Optional Menus

Each of these menus is only available if the according module is plugged in during the start up procedure or if the functionality is ordered by order code, respectively.



* Menu only available with connected alarm module during HTS801 start-up

Fig. 54 Alarm output

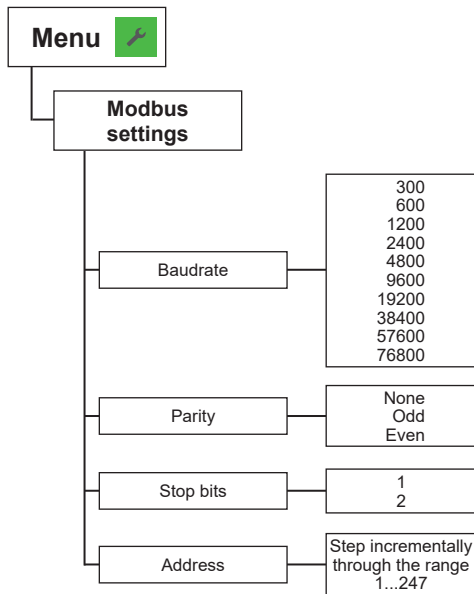

Fig. 55 Modbus settings

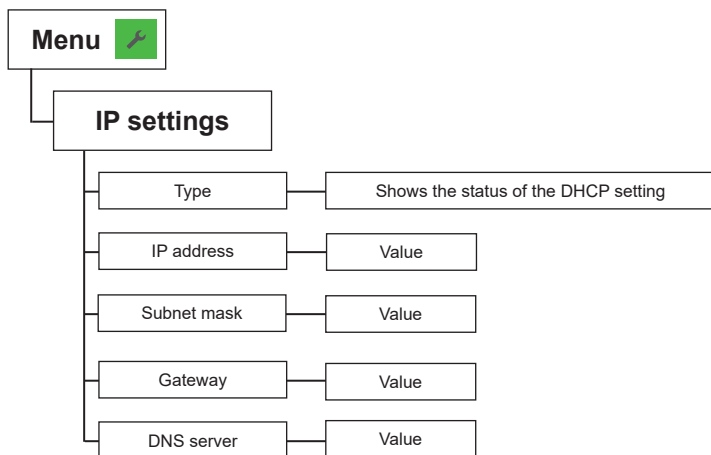
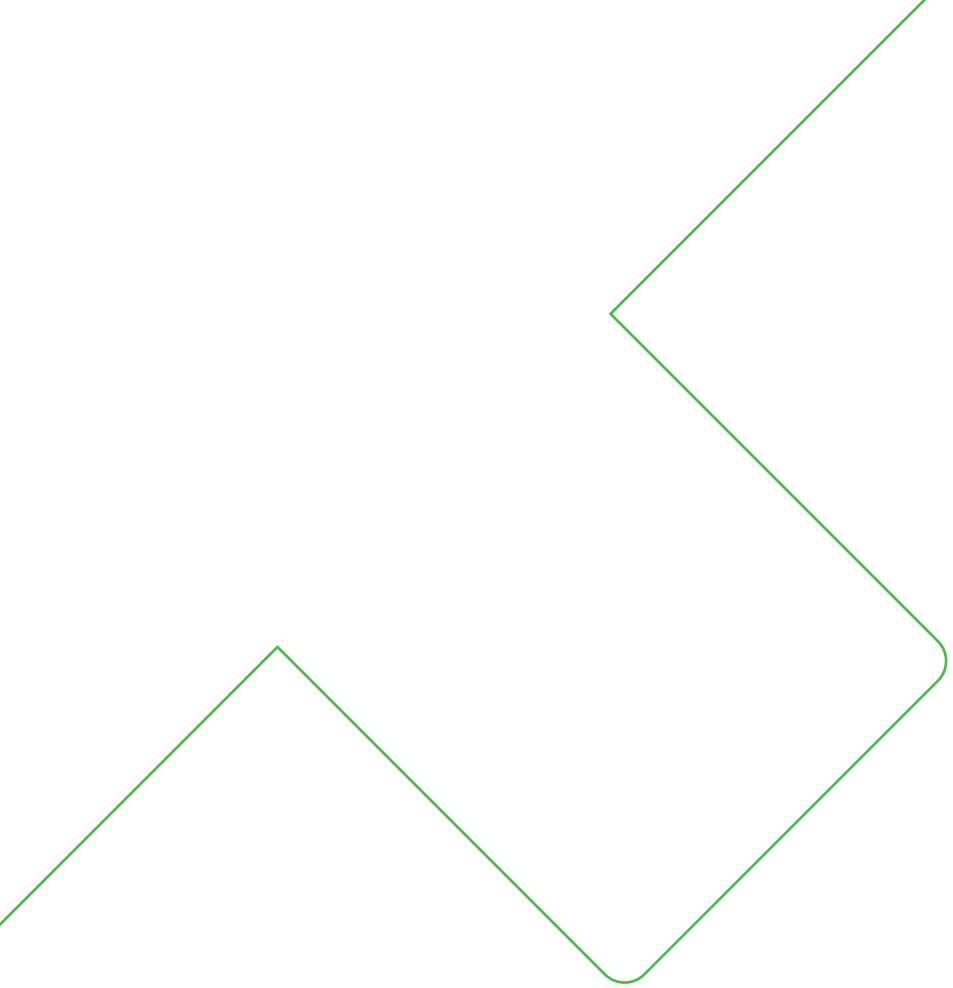

Fig. 56 IP settings



Company Headquarters &
Production Site

E+E Elektronik Ges.m.b.H.
Langwiesen 7
4209 Engerwitzdorf | Austria
T +43 7235 605-0
F +43 7235 605-8
info@epluse.com
www.epluse.com

Subsidiaries

E+E Sensor Technology (Shanghai) Co., Ltd.
T +86 21 6117 6129
info@epluse.cn

E+E Elektronik France SARL
T +33 4 74 72 35 82
info.fr@epluse.com

E+E Elektronik Deutschland GmbH
T +49 6171 69411-0
info.de@epluse.com

E+E Elektronik India Private Limited
T +91 990 440 5400
info.in@epluse.com

E+E Elektronik Italia S.R.L.
T +39 02 2707 86 36
info.it@epluse.com

E+E Elektronik Korea Ltd.
T +82 31 732 6050
info.kr@epluse.com

E+E Elektronik Corporation
T +1 847 490 0520
info.us@epluse.com



—
your partner
in sensor
technology.