



—
your partner
in sensor
technology.

+ User Manual EE360

Moisture in Oil Sensor



Content

1	General Information	3
1.1	Explanation of Warning Notices and Symbols	3
1.2	Safety Instructions	4
1.2.1.	General Safety Instructions	4
1.2.2.	Intended Use	4
1.2.3.	Alarm Module with Voltages >50 V (Option AM2)	5
1.2.4.	Integrated Power Supply 100 - 240 V AC (Option AM3)	5
1.2.5.	Mounting, Start-up and Operation	5
1.3	Environmental Aspects	6
1.4	ESD Protection	6
2	Scope of Supply	6
3	Product Description	7
3.1	Product Design	7
3.2	Dimensions	8
4	Mounting and Installation	9
4.1	Mechanical Installation	9
4.1.1.	Mounting of the Enclosure	9
4.1.2.	DIN Rail Mounting of the Polycarbonate Enclosure	10
4.2	Electrical Connection	10
4.2.1.	Electrical Connection and Wiring	12
4.3	Probe Mounting	15
4.4	Mounting Pressure Tight Probe	15
4.4.1.	Installation of the Probe Directly in the Process	15
4.4.2.	Installation of the Probe with Ball Valve Set	16
5	Optional Modules	18
5.1	Alarm Module (Option AM2)	18
5.2	Integrated Power Supply 100 - 240 V AC (Option AM3)	20
5.3	RS485 Module - Modbus RTU (Option J3)	21
5.4	Modbus Register Map	22
5.5	Modbus RTU Example	22
5.6	Ethernet Module - Modbus TCP (Option J4)	23
5.6.1.	Available TCP and UDP Ports	23
5.6.2.	IPv4 Settings	24
5.6.3.	Retrofit with Ethernet Module	25
5.7	Pluggable Probe (Option PC4)	25
6	Setup and Configuration	26
6.1	Configuration Interface	26
6.2	3.5" TFT Colour Display (optional)	27
6.3	Chart and Data Logger	27
6.4	Configuration Menu	28
6.5	Status Information	29
6.6	Buzzer ON / OFF	29
6.7	Error Indication	29
7	Maintenance and Service	30
7.1	Self Diagnosis and Error Messages	30
7.1.1.	Error Messages via Display	30
7.1.2.	Error Messages via LEDs	30
7.1.3.	Solving Typical Problems	31
7.2	Sensor Replacement	31
7.3	Cleaning the Sensing Head and Filter Replacement	32
7.4	Moisture and Temperature Calibration and Adjustment	32
8	Spare Parts and Accessories	34
9	Technical Data	35
10	Conformity	37
10.1	Declarations of Conformity	37
10.2	FCC Part 15 Compliance Statement	37
10.3	ICES-003 Compliance Statement	37
11	Appendix	38
11.1	Overview	38
11.2	Detailed Information	39
11.3	Optional Menus	42

1 General Information

This user manual serves for ensuring proper handling and optimal functioning of the device. The user manual shall be read before commissioning the equipment and it shall be provided to all staff involved in transport, installation, operation, maintenance and repair. E+E Elektronik Ges.m.b.H. does not accept warranty and liability claims neither upon this publication nor in case of improper treatment of the described products.

All information, technical data and diagrams included in this document are based on the information available at the time of writing. It may contain technical inaccuracies and typographical errors. The contents will be revised on a regular basis and changes will be implemented in subsequent versions. The described product(s) and the contents of this document may be changed or improved at any time without prior notice.

All rights reserved by E+E Elektronik Ges.m.b.H. No part of this document may be reproduced, published or publicly displayed in any form or by any means, nor may its contents be modified, translated, adapted, sold or disclosed to a third party without prior written permission of E+E Elektronik Ges.m.b.H.

PLEASE NOTE

Find this document and further product information on our website at www.epluse.com/ee360.

1.1 Explanation of Warning Notices and Symbols

Safety precautions

Precautionary statements warn of hazards in handling the device and provide information on their prevention. The safety instruction labeling is classified by hazard severity and is divided into the following groups:

DANGER

Danger indicates hazards for persons. If the safety instruction marked in this way is not followed, the hazard will very likely result in severe injury or death.

WARNING

Warning indicates hazards for persons. If the safety instruction marked in this way is not followed, there is a risk of injury or death.

CAUTION

Caution indicates hazards for persons. If the safety instruction marked in this way is not followed, minor or moderate injuries may occur.

NOTICE

Notice signals danger to objects or data. If the notice is not observed, damage to property or data may occur.

Informational notes

Informational notes provide important information which stands out due to its relevance.

INFO

The information symbol indicates tips on handling the device or provides additional information on it. The information is useful for reaching optimal performance of the device.

The title field can deviate from "INFO" depending on the context. For instance, it may also read "PLEASE NOTE".

1.2 Safety Instructions

1.2.1. General Safety Instructions

NOTICE

Improper handling of the device may result in its damage.

- Avoid any unnecessary mechanical stress and inappropriate use.
- When replacing the filter cap make sure not to touch the sensing elements.
- For sensor cleaning and filter cap replacement please see “Cleaning instructions” at www.epluse.com.
- Installation, electrical connection, maintenance and commissioning shall be performed by qualified personnel only.
- The devices are designed for the operation with class III supply (EU) and class 2 supply (NA).
- The power supply must be switched off before opening the housing.
- An existing Ethernet connection must be disconnected before opening the housing.

1.2.2. Intended Use

EE360 is optimized for reliable measurement in lubrication, hydraulic and insulation oils as well as diesel fuel. In addition to highly accurate measurement of water activity (aw) and temperature (T), EE360 calculates the absolute water content (x) in ppm. The probe can be used up to 180 °C (356 °F), 20 bar (290 psi) and is available with either ISO or NPT sliding fitting, which allows for variable immersion depth. Using the optional ball valve, the probe can be mounted or removed even without process interruption.

WARNING

The manufacturer cannot be held responsible for damages as a result of incorrect handling, installation and maintenance of the device.

- This device is not appropriate for safety, emergency stop or other critical applications where device malfunction or failure could cause injury to human beings.
- The device may not be manipulated with tools other than specifically described in this manual.

NOTICE

Failing to follow the instructions in this user manual may lead to measurement inaccuracy and device failures.

- The EE360 may only be operated under the conditions described in this user manual and within the specification included in chapter 9 Technical Data.
- Unauthorized product modification leads to loss of all warranty claims. Modification may be accomplished only with an explicit permission of E+E Elektronik Ges.m.b.H.!

The moisture in oil can be expressed in absolute or relative terms:

- The **water activity aw** is the relative measure for moisture in oil. It represents the ratio between the actual amount of dissolved water and the maximum possible amount of dissolved water in the oil at a certain temperature T. Independently of the oil type, the water activity shows how close to saturation is the oil at a certain temperature.
aw = 0 indicates completely dry oil
aw = 1 fully saturated oil
EE360 measures directly the water activity.
- The **water content x** is an absolute measure equal to the share of water (dissolved, emulsified or separate) in the oil. The water content is measured in ppm (parts per million) and is independent from the oil temperature. For assessing how far is the oil from saturation, x must be regarded together with T. EE360 calculates x out of the measured aw and T values. The calculation is oil dependent and requires a set of oil specific parameters. (Contact an E+E representative for details.)

1.2.3. Alarm Module with Voltages >50 V (Option AM2)

The optional alarm module is isolated from the low-voltage side of EE360 by a special partition; this must remain fitted at all times in the base module of the enclosure.

WARNING

An open enclosure corresponds to IP00 and exposes components carrying dangerous voltage. The EE360 enclosure must be tightly closed during operation. Any work (maintenance for instance) on the device may be performed by qualified staff only.

1.2.4. Integrated Power Supply 100 - 240 V AC (Option AM3)

The EE360 enclosure must be tightly closed during operation.

WARNING

An open enclosure corresponds to IP00 and exposes components carrying dangerous voltage. Any work (maintenance for instance) on the device may be performed by qualified staff only.

An open enclosure corresponds to IP00 and exposes components carrying dangerous voltage. Any work (maintenance for instance) on the device may be performed by qualified staff only.

1.2.5. Mounting, Start-up and Operation

The EE360 has been produced under state of the art manufacturing conditions, has been thoroughly tested and has left the factory after fulfilling all safety criteria. The manufacturer has taken all precautions to ensure safe operation of the device. The user must ensure that the device is set up and installed in a way that does not impair its safe use. The user is responsible for observing all applicable local and international safety guidelines for safe installation and operation of the device. This user manual contains information and warnings that must be observed by the user in order to ensure safe operation.

PLEASE NOTE

The manufacturer or his authorized agent can be only be held liable in case of willful or gross negligence. In any case, the scope of liability is limited to the corresponding amount of the order issued to the manufacturer. The manufacturer assumes no liability for damages incurred due to failure to comply with the applicable regulations, operating instructions or the specified operating conditions. Consequential damages are excluded from the liability.

WARNING

Non-compliance with the product documentation may cause safety risk for persons (accidents, personal injury) or damage to property (measurement installation).

- Mounting, installation, commissioning, start-up, operation and maintenance of the device may be performed by qualified staff only. Such staff must be authorized by the operator of the facility to carry out the mentioned activities.
- The qualified staff must have read and understood this user manual and must follow the instructions contained within.
- All process and electrical connections shall be thoroughly checked by authorized staff before putting the device into operation.
- Do not install or start-up a device supposed to be faulty. Make sure that such devices are not accidentally used by marking them clearly as faulty.
- A faulty device may only be investigated and possibly repaired by qualified, trained and authorized staff. A faulty device shall be removed from the process.
- Service operations other than described in this user manual may only be performed by the manufacturer.

1.3 Environmental Aspects

PLEASE NOTE

Products from E+E Elektronik Ges.m.b.H. are developed and manufactured in compliance with all relevant environmental protection requirements. Please observe local regulations for the disposal of the device.



For disposal, the individual components of the device must be separated according to local recycling regulations. The electronics shall be disposed of correctly as electronics waste.

1.4 ESD Protection



The sensing elements and the electronics board are ESD (electrostatic discharge) sensitive components of the device and must be handled as such. The failure to do so may damage the device by electrostatic discharges when touching exposed sensitive components.

2 Scope of Supply

Items included	Version
EE360 Moisture in Oil Sensor Applications according to ordering guide	All versions
User manual	All versions
Inspection certificate according to DIN EN 10204-3.1	All versions
Two self-adhesive labels for configuration changes (see user manual at www.epluse.com/relabeling)	All versions
Mating plug for integrated power supply	AM3
Mating plug RKC 5/7	AM3 / E4 / E6 / E12
Mating plug RSC 5/7 (2 pcs. for option E12)	E5 / E6 / E12
Mating plug HPP V4 RJ45 Cat5	J4

Tab. 1 Items included in the scope of supply

3 Product Description

3.1 Product Design



Fig. 1 EE360 product design

No.	Function
1	Sensor module with electronic / display ^{*)} and probe cable
2	3.5" TFT colour display ^{*)}
3	5 push-buttons for configuration menu
4	Base module with electrical connection, alarm + supply module ^{*)} and mounting holes
5	Micro USB service interface
6	Standard cable glands / connectors ^{*)}
7	Additional cable gland / connector ^{*)}

^{*)} Optional

Tab. 2 Parts of the EE360

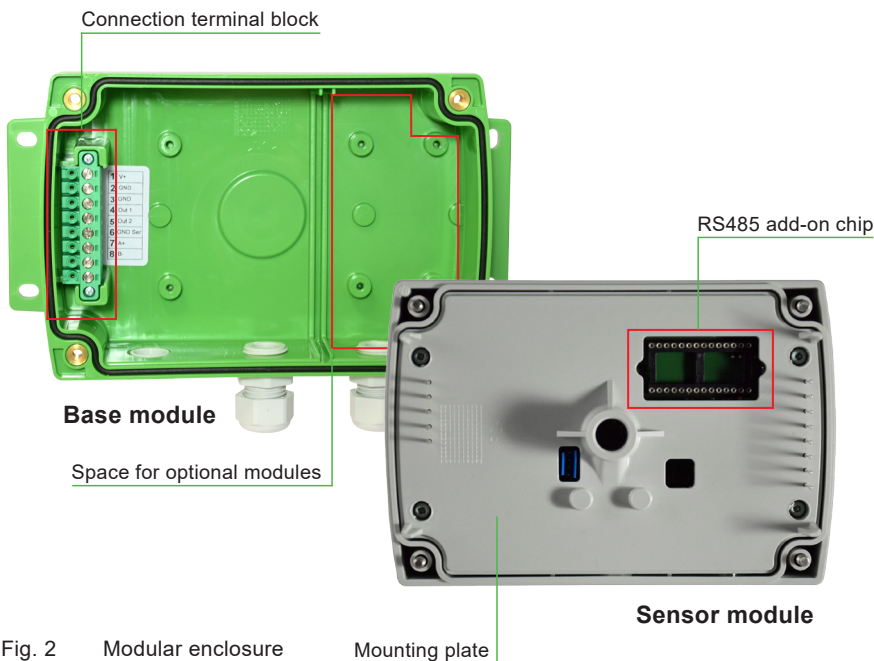

Fig. 2 Modular enclosure

3.2 Dimensions

Values in mm (inch)

Enclosure

Polycarbonate

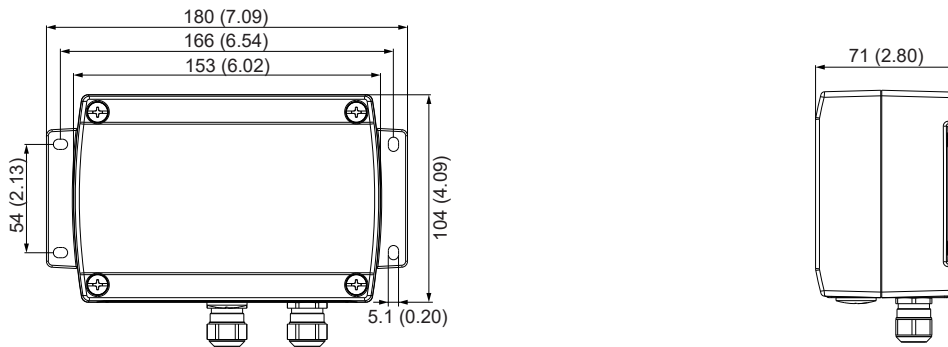

Enclosure

Stainless steel

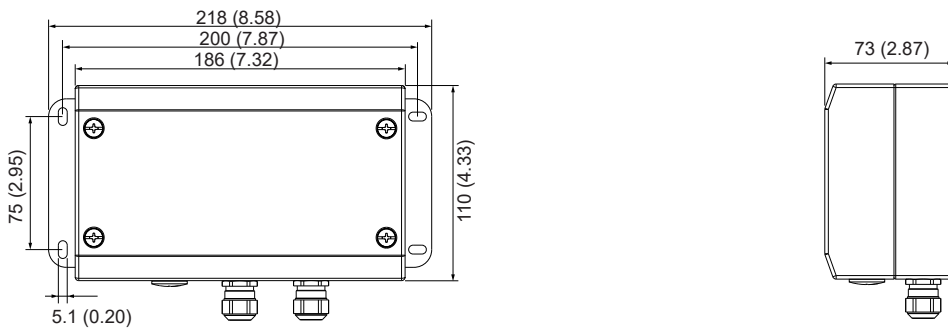

Probe

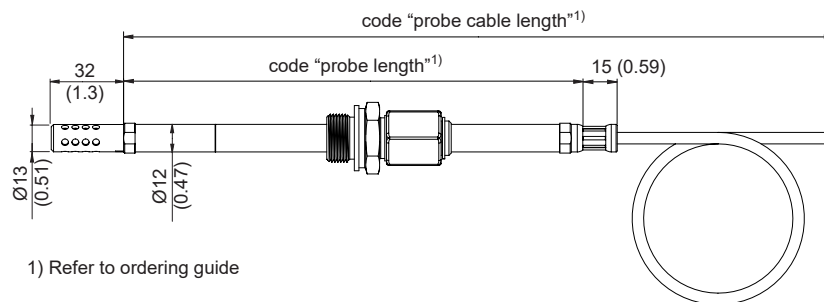

Probe

Minimum insertion depth

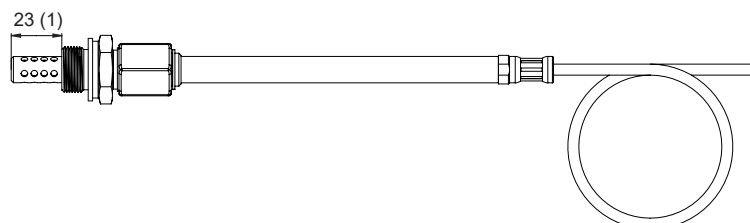

Probe

Maximum insertion depth

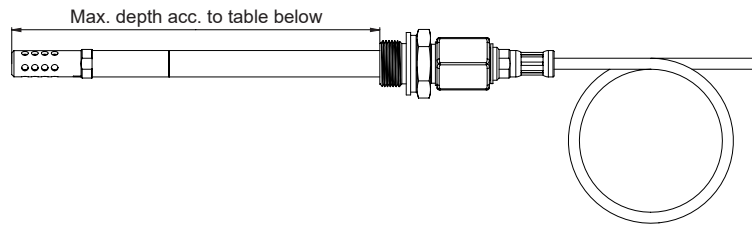

Ball valve set G 1/2" ISO or NPT

Probe length [mm (inch)]	Max. insertion depth [mm (inch)]
100 (2.5)	64 (3.9)
200 (6.5)	164 (7.9)
400 (14.3)	364 (15.8)
600 (22.2)	564 (23.6)
800 (30.1)	764 (31.59)
1000 (38.0)	964 (39.4)

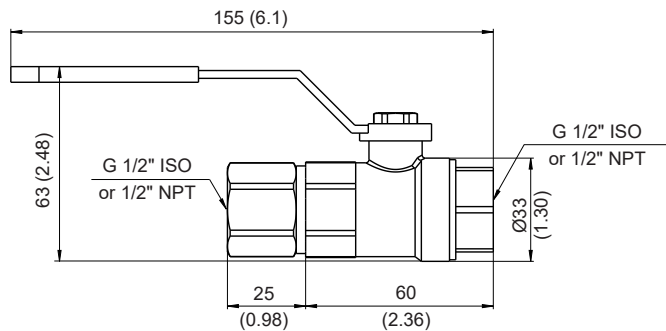

4 Mounting and Installation

4.1 Mechanical Installation

4.1.1. Mounting of the Enclosure

- Drill the mounting holes according to the corresponding mounting pattern below.
- Mount the base module of the enclosure with 4 screws (screw diameter <4.2 mm (0.2"), not included in the scope of supply). Values in mm (inch).

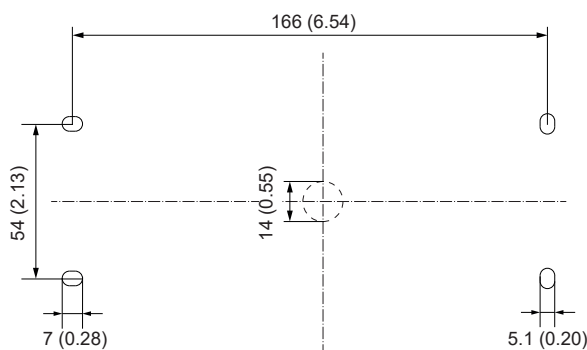

Fig. 3 Drilling pattern of polycarbonate enclosure

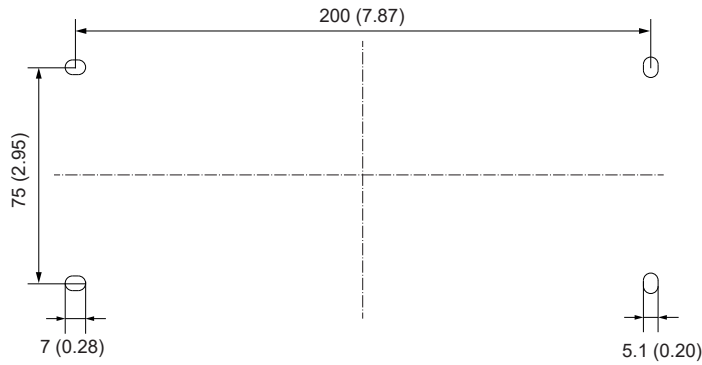

Fig. 4 Drilling pattern of stainless steel enclosure

4.1.2. DIN Rail Mounting of the Polycarbonate Enclosure

- Mount the two DIN rail brackets onto the base module.
(to be ordered separately, see chapter 8 Spare Parts and Accessories)
- Snap in the enclosure onto the DIN rail.

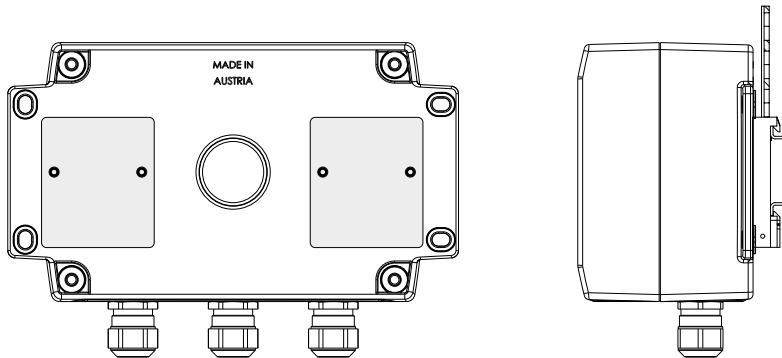

Fig. 5 DIN rail installation

4.2 Electrical Connection

NOTICE

The electrical installation of the EE360 shall be performed by qualified personnel only. Observe all applicable national and international requirements for the installation of electrical devices as well as for power supply according to EN 61140, class III (EU) and class 2 supply (North America).

⚠ WARNING

Incorrect installation, wiring or power supply may cause overheating and therefore personal injuries or damage to property.

For correct cabling of the device, always observe the presented wiring diagram for the product version used.

The manufacturer cannot be held responsible for personal injuries or damage to property as a result of incorrect handling, installation, wiring, power supply and maintenance of the device.

Connection Diagram

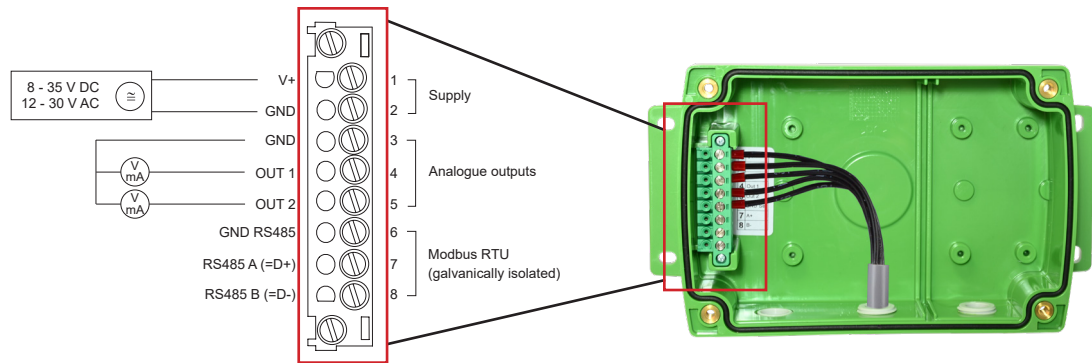

Fig. 6 Electrical connection

Analogue outputs

Both analogue outputs shall be configured to either voltage or current. Measurands, analogue output range and scaling are freely selectable. All settings can be performed via display and push buttons or using the PCS10 Product Configuration Software, see 6.1 Configuration Interface.

Error indication

The analogue outputs feature an error indication function according to NAMUR NE43. In the case of an error the output signal will freeze at 21 mA or 11 V respectively.

i PLEASE NOTE

The error display is disabled by default.

When changing one of the analogue outputs from current to voltage and vice versa, the second output will change automatically as well. The output scaling changes automatically if it is out of physical range (i.e. 20 mA will be changed to 10 V instead of 20 V).

i PLEASE NOTE

Check output scale after changing between voltage and current output.

4.2.1. Electrical Connection and Wiring

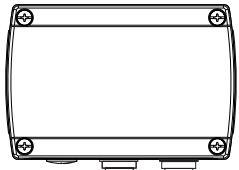
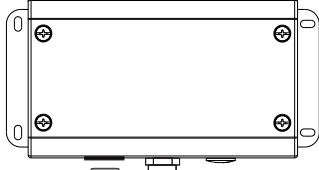
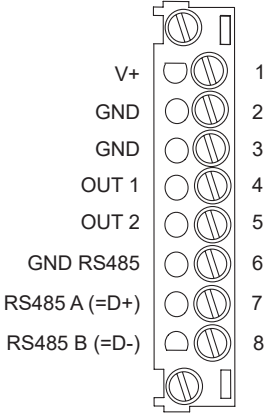
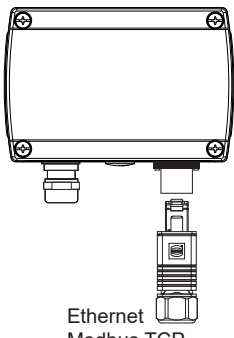
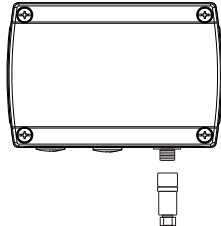
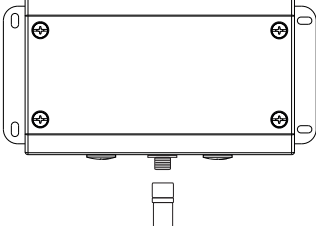
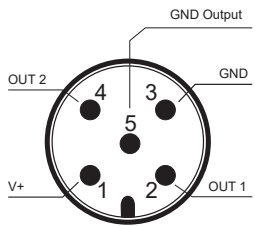
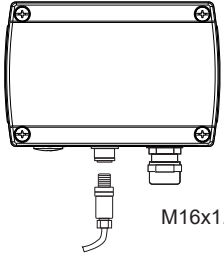
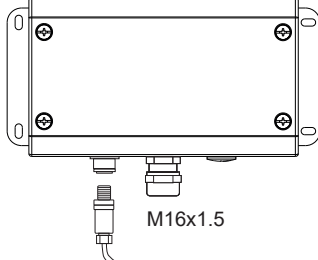
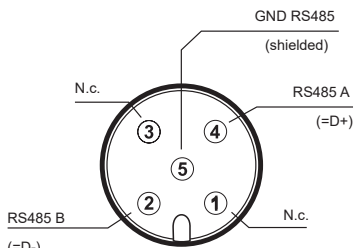
Option	Polycarbonate Enclosure	Stainless Steel Enclosure	Pin Assignment
Cable glands	 <p>2x M16x1.5</p>	 <p>1 x M16x1.5 mounted 1 x M16x1.5 enclosed</p>	 <p>V+ 1 GND 2 GND 3 OUT 1 4 OUT 2 5 GND RS485 6 RS485 A (=D+) 7 RS485 B (=D-) 8</p>
J4	 <p>Ethernet Modbus TCP</p>		
E4	 <p>Power supply + analogue output</p>	 <p>Power supply + analogue output</p>	 <p>M12 plug front view</p>
E5	 <p>M16x1.5 Modbus RTU</p>	 <p>M16x1.5 Modbus RTU</p>	 <p>M12 socket front view</p>

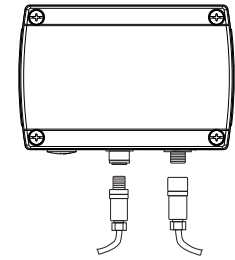
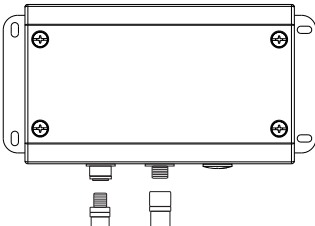
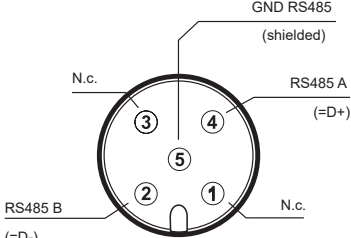
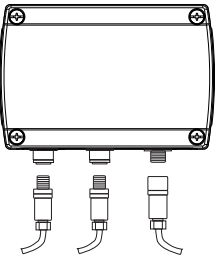
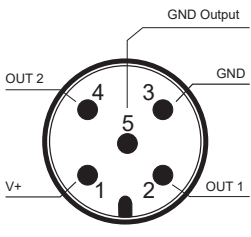
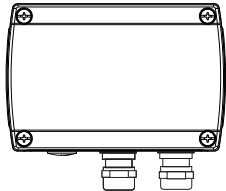
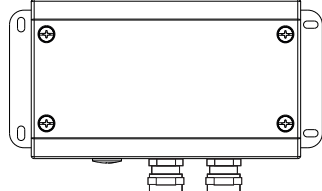
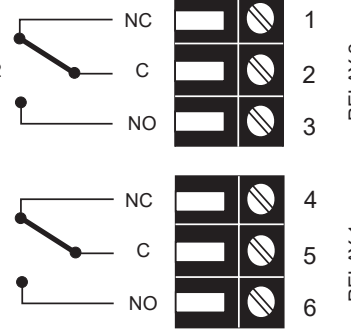
Option	Polycarbonate Enclosure	Stainless Steel Enclosure	Pin Assignment
E6	 <p>Modbus RTU Power supply + analogue output</p>	 <p>Power supply + analogue output Modbus RTU</p>	 <p>Modbus RTU M12 socket front view</p>
E12	 <p>Modbus RTU Power supply + analogue output</p>		 <p>Power supply + analogue output M12 plug front view</p>
AM2	 <p>2x M16x1.5</p>	 <p>2x M16x1.5</p>	 <p>Standard operation mode</p> <p>Inverted operation mode</p>

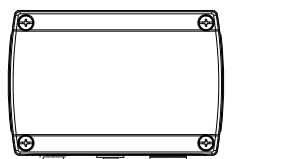
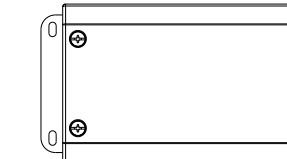
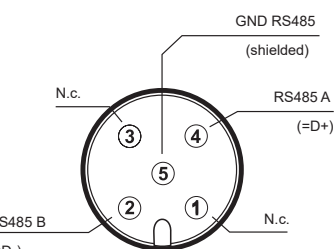
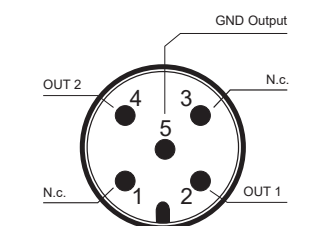
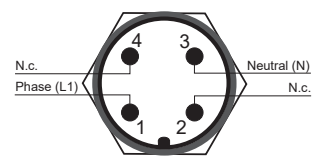
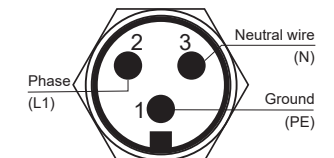
Option	Polycarbonate Enclosure	Stainless Steel Enclosure	Pin Assignment
AM3	 <p>Modbus RTU (only with order code J3)</p> <p>Analogue output</p> <p>Power supply</p>	 <p>Modbus RTU (only with order code J3)</p> <p>Analogue output</p> <p>Power supply 100 - 240 V AC</p>	 <p>Modbus RTU M12 socket front view</p>  <p>Analogue output M12 plug front view</p>  <p>Power supply 100 - 240 V AC for polycarbonate enclosure Plug, 4 poles front view</p>  <p>Power supply 100 - 240 V AC for stainless steel enclosure Plug, 3 poles front view</p>

Tab. 3 Options for electrical connections and wiring

NOTICE

External diameter of the supply cable for option AM3: 10...12 mm (0.39...0.47").
 Maximum wire cross section for AM3 connecting cable: 1.5 mm² (AWG 16) .

External diameter of the cable for Modbus RTU and analogue output female plug: 4...6 mm (0.16...0.24").
 Maximal wire cross section for connecting cable: 0.5 mm² (AWG 21).

4.3 Probe Mounting

The probe can be installed in applications such as oil storages with almost non-moving oil or as well in circulation pipes with moving oil.

NOTICE

In moving oil, the mechanical stress on the probe is minimized by only placing the filter cap into the flow. In systems with mechanical oil contaminants the sensor may get installed only after an appropriate filter.

4.4 Mounting Pressure Tight Probe

WARNING

General safety instructions for installation

The installation, commissioning and operation of the EE360 may be performed by qualified staff only. Special attention shall be paid to the correct installation of the probe into the process. In case of inappropriate installation there is the risk for the probe to be suddenly expelled due to the pressure in the process.

Bending over the sensing probe should be avoided under any circumstances!

Make sure that the surface of the probe is not damaged during installation. A damaged probe surface may lead to damaged seals and consequently to leakage and pressure loss.

The probe is rated with leakage rate B according to EN12266-1.

4.4.1. Installation of the Probe Directly in the Process

NOTICE

For direct probe installation shut-off valves shall be placed on both sides of the probe insert (see Fig. 7 Installation of the EE360 probe directly into the process). This allows the sensor probe to be easily removed for maintenance and calibration.

For direct installation into a pressure chamber make sure that the pressure in the chamber and the ambient pressure are equal before removing the probe. The temperature during probe installation may deviate by max. ± 40 °C (± 72 °F) from the regular temperature during normal operation.

Replace the metal sealing ring (see Fig. 7) by a new one every time before re-installing the probe.

Probe installation steps

1. Close both shut-off valves.
2. Place the sensor probe into the probe insert and adjust the immersion depth.
3. Tighten the lock nut with a torque of 30 Nm.
4. Open the shut-off valves.

WARNING

Observe strictly the tightening torque. A torque lower than 30 Nm results in a smaller retention force of the clamping sleeve. This leads the risk of sudden expulsion of the sensing probe due to the pressure. A torque higher than 30 Nm may lead to permanent deformation of the clamping sleeve and the sensing probe. This would make the removal and re-installation of the probe difficult or even impossible.

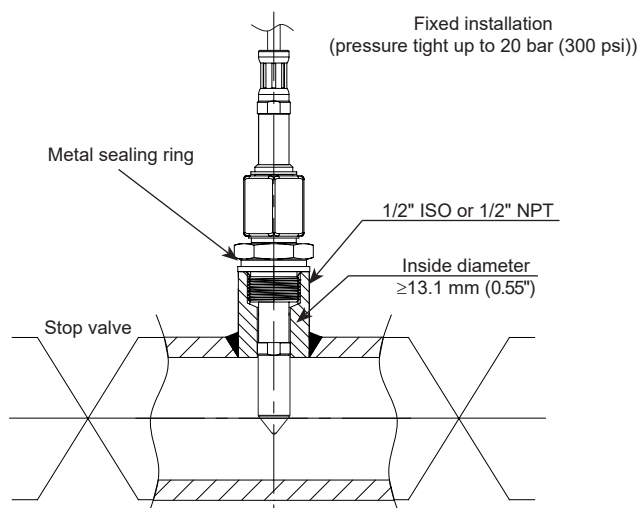

Fig. 7 Installation of the EE360 probe directly into the process

4.4.2. Installation of the Probe with Ball Valve Set

The ball valve set allows for installation and removal of the probe without process interruption. For mounting into a duct, the ball valve shall be installed perpendicular to the flow direction.

NOTICE

The two metal sealing rings (see Fig. 8 Installation of the probe by utilizing the ball valve set) shall be replaced every time prior to re-installing the probe.

The temperature during probe installation may deviate by max. ± 40 °C (± 72 °F) from the regular temperature during normal operation.

Installation of the probe (see Fig. 8)

1. Install the probe into the ball valve while the ball valve is closed.
2. Open the ball valve.
3. Slide the probe through the ball valve to the desired immersion depth. Depending on the process pressure additional tools may be necessary for pushing the probe into the process. Make sure not to damage the probe and the cable.
4. Tighten the lock nut with a torque of 30 Nm.

⚠ WARNING

Observe strictly the tightening torque. A torque lower than 30 Nm results a smaller retention force of the clamping sleeve. This leads the risk of sudden expulsion of the sensing probe due to the pressure. A torque higher than 30 Nm may lead to permanent deformation of the clamping sleeve and the sensing probe. This would make the removal and re-installation of the probe difficult or even impossible.

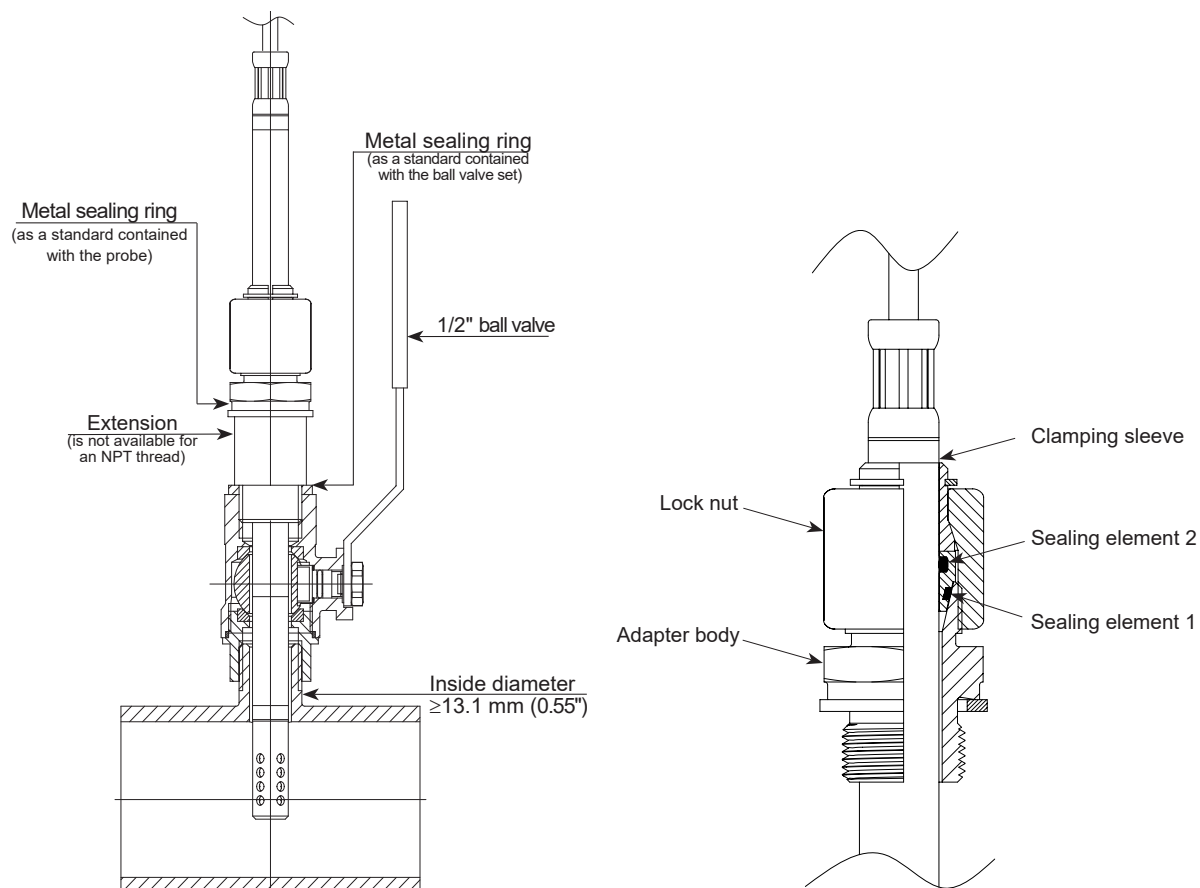

Fig. 8 Installation of the probe by utilizing the ball valve set

Removing the probe

1. Hold firmly the probe to avoid it being suddenly expulsed when releasing the lock. Do not bend damage the probe cable.
2. Loosen slowly the lock nut with a spanner (spanner width 24) only till the probe is pushed out by the overpressure in the process. Do not completely loosen the lock nut, but only as much as necessary for the probe to slide.
3. After the probe has been pushed out of the process up to the stop, close the ball valve.
4. Remove the probe from the ball valve.

NOTICE

Observe the correct positioning of the sealing element 1 before reinstalling the probe.

Replacement of the sealing element

In case of repeated installations and removals the sealing element 1 can be damaged. It can be replaced by the user.

Sealing element 1

O-ring seal 13x1.5 mm
FPV3588 Sh A 60±5

5 Optional Modules

5.1 Alarm Module (Option AM2)

The module offers two freely configurable relay outputs for alarm or control purposes. Various operation modes are available including switch hysteresis, switch window and error indication. The error modes can be configured independently from each other. The measurands at the outputs as well as switching points, hysteresis and the normal state (standard / inverted) can be set via PCS10 Product Configuration Software or using the push-buttons (see chapter 11.3 Optional Menus, Fig. 39 Alarm output).

Electrical Connection and Switch Load

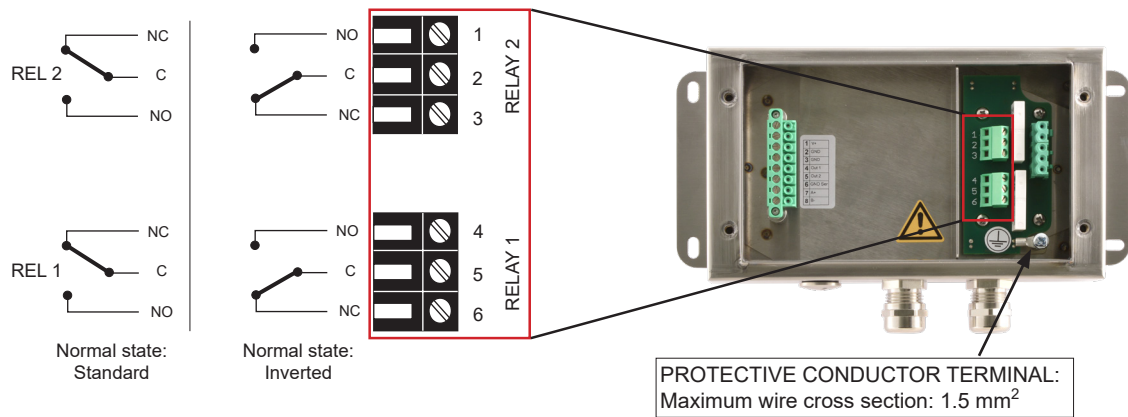

Fig. 9 Alarm module (option AM2)

⚠ WARNING

The metal enclosure must be grounded during operation. National regulations for installation must be observed!

Switch Load

Max. switch load	250 V AC / 6 A 28 V DC / 6 A
Min. switch load	12 V / 100 mA

Tab. 4 Maximum and minimum switch loads

⚠ WARNING

No overcurrent and short circuit protection. Both relays shall be connected to either high or low voltage.

Switch Hysteresis Mode

The switching behavior is determined by entering a switching point and an associated hysteresis value.

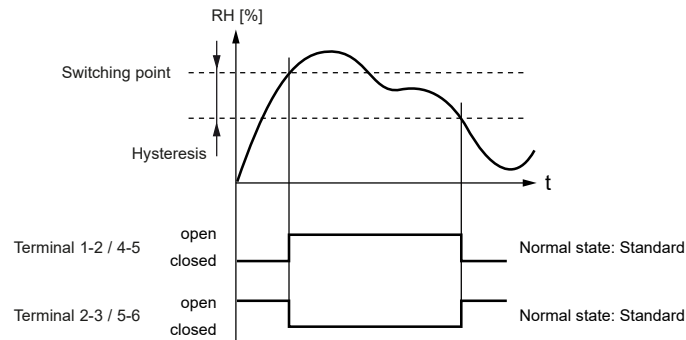

Fig. 10 Example hysteresis mode on both alarm outputs using normal state standard

Additionally, detected errors are signaled at the alarm output.

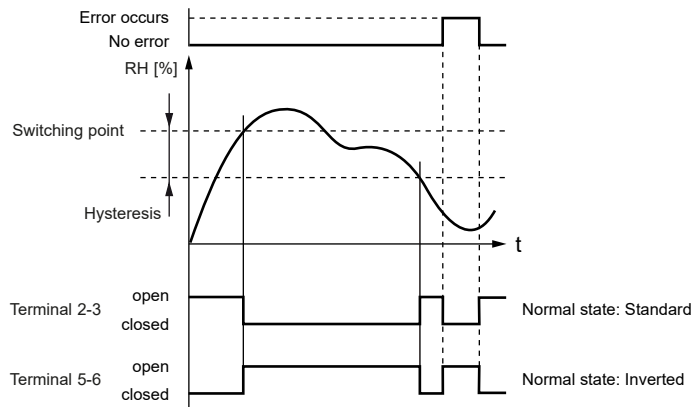

Fig. 11 Example of hysteresis mode with error occurring.

Switch Window Mode

The switching behavior is determined by entering two switching points and two associated hysteresis values.

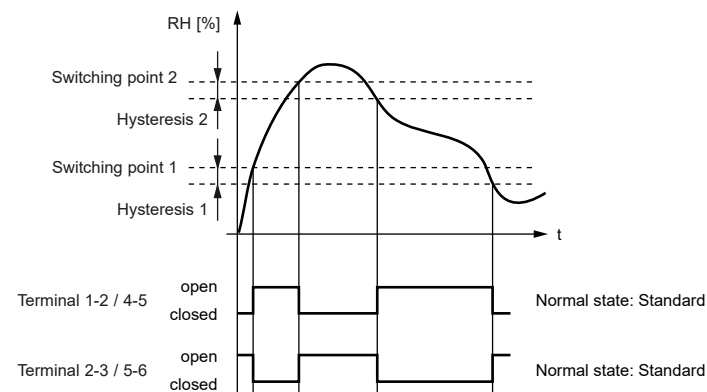

Fig. 12 Example window mode on both alarm outputs using normal state standard

Additionally, detected errors are signaled at the alarm output.

Error Indication Mode

When error indication mode is selected, various errors will trigger the alarm output.

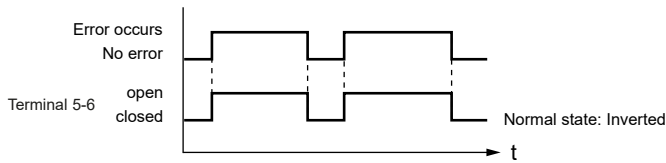

Fig. 13 Example of error mode on relay 1 using normal state inverted.

i PLEASE NOTE

An alarm output in this operation mode is used for error indication only (no combination with switching points possible).

i PLEASE NOTE

When error indication mode is selected, various errors will trigger the alarm output. An alarm output in this operation mode is used for error indication only.

5.2 Integrated Power Supply 100 - 240 V AC (Option AM3)

This module allows the EE360 to be powered with 100 - 240 V AC (50/60 Hz), 2 VA.

Enclosure

Polycarbonate

Stainless steel

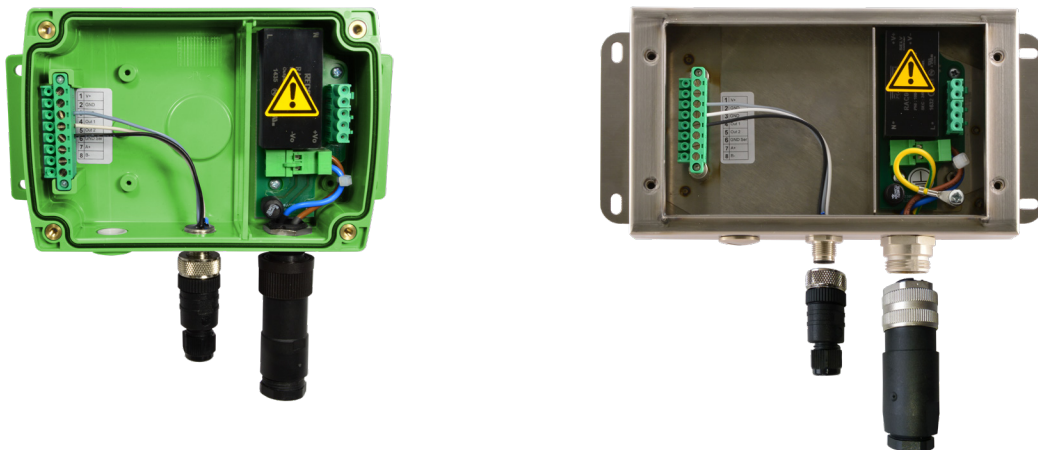

Fig. 14 Power supply module (option AM3)

Pin assignment of the plug connection: please refer to chapter 4.2.1 Electrical Connection and Wiring.

! WARNING

The AM3 option includes a 1.25 A fuse on the 100 - 240 V side. This fuse may not be replaced by the user, only by the E+E after sales service.

The protection of the supply cable against excess current and short-circuit must be designated to a wire cross section of 0.8 mm² (AWG 18) (6A fuse).

The metal enclosure must be grounded during operation.

All national regulations for installation shall be observed!

5.3 RS485 Module - Modbus RTU (Option J3)

The device represents a unit load of 1, i.e. up to 32 EE360 sensors with Modbus RTU interface can be connected in an RS485 bus system.

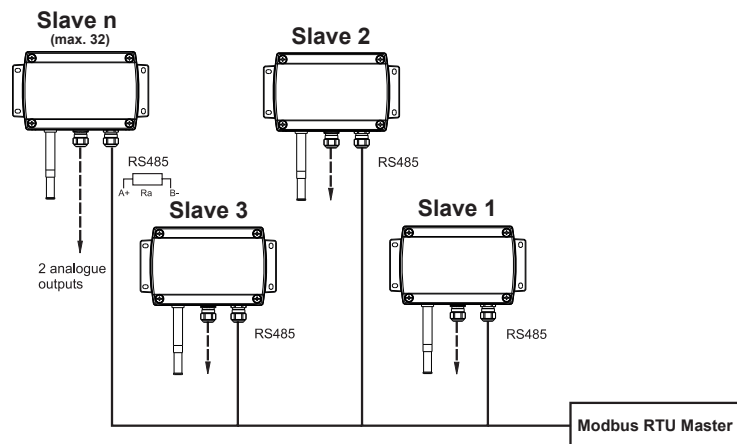

Fig. 15 2-wire RS485 bus

i PLEASE NOTE

Both ends of the bus shall be terminated with a resistor $R_a=120 \Omega$.

The setup of the Modbus RTU communication can be performed via PCS10 Product Configuration Software or via display and push buttons (see chapter 11 Appendix, Fig. 40 Modbus settings).

Modbus RTU Protocol Settings

	Factory settings	Selectable values (via PCS10)
Baud rate	9600	300, 600, 1 200, 2 400, 4 800, 9 600, 19 200, 38 400, 57 600, 76 800
Data bits	8	8
Parity	Even	None, odd, even
Stop bits	1	1 or 2
Modbus address	231	1...247

Tab. 5 Modbus RTU Protocol Settings

i PLEASE NOTE

The recommended setting for multiple devices in a Modbus RTU network is 9600, 8, Even, 1.

Device address, baud rate, parity and stop bits can be set via:

- EE-PCS Product Configuration Software6.
The EE-PCS10 can be downloaded free of charge from www.epluse.com/configurator.
- Modbus protocol in register 1 (0x00) and 2 (0x01).
See Application Note Modbus AN0103 (available at www.epluse.com/ee360).

The serial number as ASCII-code is located in read-only registers 1 - 8 (0x00 - 0x07).

The firmware version is located in read-only register 9 (0x08) (bit 15...8 = major release; bit 7...0 = minor release).

The sensor name as ASCII-code is located in read-only registers 10 - 17 (0x09 - 0x11).

NOTICE

When reading information that spans multiple registers, it is always necessary to read all registers, even if the desired information requires less.

NOTICE

For obtaining the correct floating point values, both registers have to be read within the same reading cycle. The measured value can change between two Modbus requests, exponent and mantissa may get inconsistent then.

Communication settings (INT16)

Parameter	Register number ¹⁾ [Dec]	Register address ²⁾ [Hex]	Size ³⁾
Write register: function code 0x06			
Modbus address ⁴⁾	1	00	1
Modbus protocol settings ⁴⁾	2	01	1

Device information (INT16)

Parameter	Register number ¹⁾ [Dec]	Register address ²⁾ [Hex]	Size ³⁾
Read register: function code 0x03 / 0x04			
Serial number (as ASCII)	1	00	8
Firmware version	9	08	1
Sensor name	10	09	8

1) Register number (decimal) starts from 1.

2) Register address (hexadecimal) starts from 0.

3) Number of registers

4) For Modbus address and protocol settings see Application Note Modbus AN0103 (available at www.epluse.com/ee360).

Tab. 6 EE360 registers for device setup

5.4 Modbus Register Map

The measured data is saved as a 32 bit floating point values (data type FLOAT32) and as 16 bit signed integer values (data type INT16).

FLOAT32

Parameter	Unit	Register number ¹⁾ [DEC]	Register address ²⁾ [HEX]
Read register: function code 0x03 / 0x04			
Water activity aw	-	1135	46E
Water content x	ppm	1141	474
Temperature T	°C	1003	3EA
	°F	1005	3EC
Saturation	%	1137	470
Oil parameter A	-	0224	DF
Oil parameter B	-	0226	E1
Write register: function code 0x10			
Oil parameter A ³⁾	-	0101	64
Oil parameter B ³⁾	-	0103	66

1) Register number starts from 1.

2) Register address starts from 0.

3) Examples: Writing Parameter A-2663.30005 decimal: E7 10 00 64 00 02 04 74 CD C5 26 E5 BA
Writing Parameters A and B -1663.30005 and 7.3705 decimal: E7 10 00 64 00 04 08 E9 9A C4 CF DB 23 40 EB AB 61
If two parameters are to be uploaded, it is recommended to write them with a single command.

Tab. 7 EE360 FLOAT32 measured data registers

5.5 Modbus RTU Example

The EE360's Modbus address is 231 [E7 in HEX].

Please refer to

- MODBUS APPLICATION PROTOCOL SPECIFICATION V1.1b3, chapter 6:
www.modbus.org/docs/Modbus_Application_Protocol_V1_1b3.pdf
- E+E Application Note Modbus AN0103 (available at www.epluse.com/ee360)

Read the temperature (FLOAT32) T = 26.953624 °C from the register 0x3EA:

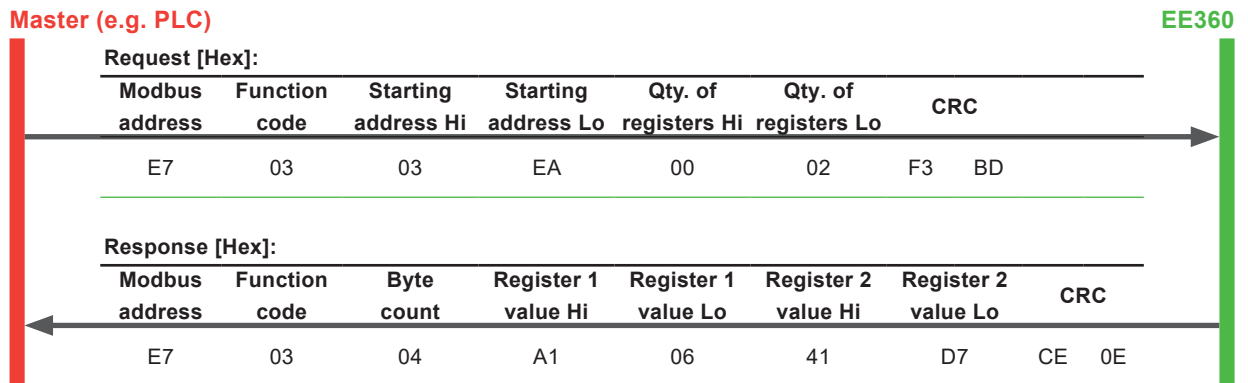

Tab. 8 Example temperature query

Decoding of floating point values:

Floating point values are stored according to IEEE754. The byte pairs 1, 2 and 3, 4 are transformed as follows (numbers taken from T reading Modbus request/response example above):

Modbus response [Hex]

Register 1 Hi	Register 1 Lo	Register 2 Hi	Register 2 Lo
A1	06	41	D7
MMMMMMMM	MMMMMMMM	SEEEEEEE	EMMMMMMM

Tab. 9 Modbus response

IEEE754

Register 2 Hi	Register 2 Lo	Register 1 Hi	Register 1 Lo
41	D7	A1	06
0100 0001	1101 0111	1010 0001	0000 0110
SEEE EEEE	EMMM MMMM	MMMM MMMM	MMMM MMMM

Decimal value: 26.953624725341796875

Tab. 10 Data representation according to IEEE754

5.6 Ethernet Module - Modbus TCP (Option J4)

The Ethernet module features power over Ethernet (PoE) and RJ45 connector with IP65 protection rating.

i PLEASE NOTE

The Ethernet connection shall be disconnected before opening the enclosure.

5.6.1. Available TCP and UDP Ports

Modbus TCP (Port 502)

See “Modbus TCP/IP implementation guide” available at www.modbus.org/docs/Modbus_Messaging_Implementation_Guide_V1_0b.pdf.

The unit identifier of the MBAP header is not used and can be any value from 0 to 255.

HTTP-Webserver (Port 80)

For a quick communication check enter the desired IP in a web browser and connect with the EE360 Ethernet Module’s Webserver.

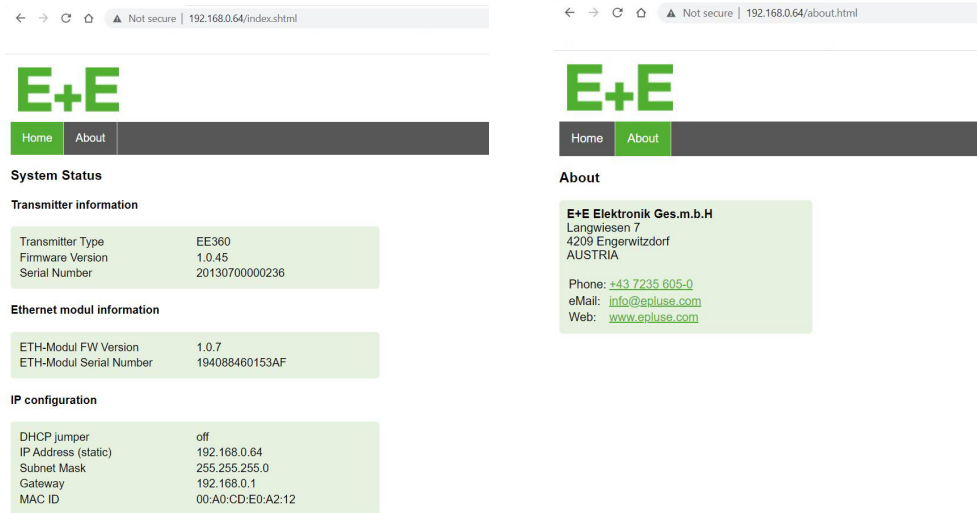

Fig. 16 Image from the E+E net web interface

Alternatively, send an ICMP echo request (“ping”) to check correct communication settings.

UDP (Port 5234)

Backwards compatible communication protocol with EE36. Communication via Ethernet takes place by means of UDP packets, which transport a command or a command response in EE36 protocol format as payload data. See “Ethernet - communication protocol” available at www.epluse.com/en/service-support/download-center.

5.6.2. IPv4 Settings

Factory setting	
IP Address	192.168.0.64
Subnet Mask	255.255.255.0
Gateway	192.168.0.1
DNS	192.168.0.1

Tab. 11 IPv4 settings

DHCP options can be set with jumper on the PCB.
 Factory setting: DHCP disabled (static IP). Please refer to Fig. 17 below.

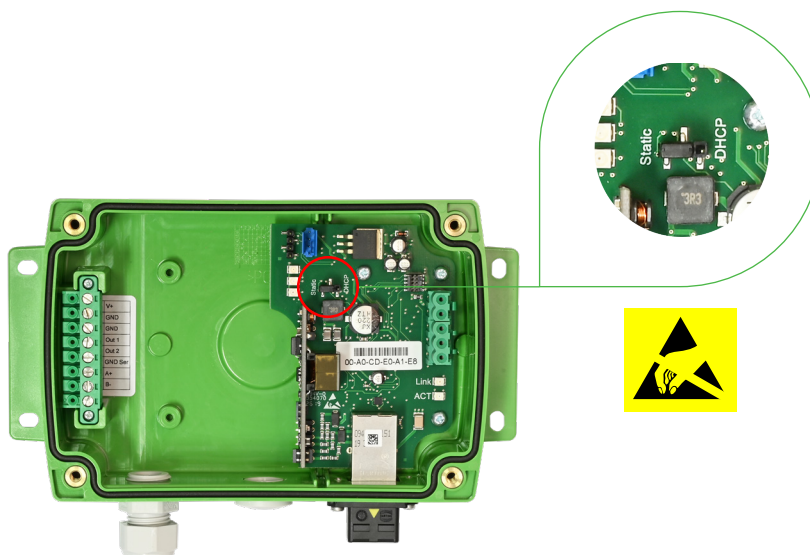

Fig. 17 Ethernet Module - DHCP setting

The setup of the Modbus TCP communication can be performed via PCS10 Product Configuration Software or via display and push buttons (see 11 Appendix, Fig. 41 IP settings).

Changing the IP address via PCS10 or the display is only possible if the DHCP jumper is set to "Static". Otherwise the IP settings are read-only.

NOTICE

Supported Ethernet standard: 802.3i/u/x and af. IPv6 is not supported.

5.6.3. Retrofit with Ethernet Module

The EE360 can be retrofitted with an Ethernet module. Before retrofitting, please make sure that the EE360 firmware is updated to the latest version by using the PCS10 Product Configuration Software.

- Firmware for sensor: V 1.0.22 or higher
- Firmware for display: V 1.0.9 or higher

Description	Order Code
Ethernet Module for remote probe	HA010606

Tab. 12 Accessories order code

5.7 Pluggable Probe (Option PC4)

EE360 sensors are optionally available with pluggable sensing probe, which is attached to the EE360 enclosure by a push-pull plug. If the probe or the probe cable gets damaged it is possible to easily replace the probe without humidity and temperature adjustment. The replacement probe (see 8 Spare Parts and Accessories) is supplied with a set of 7 individual parameters.

i PLEASE NOTE

When using two or more devices at the same time, do not mix up the sensors. The serial number of the connected sensor can be read by scanning the barcode on the basic unit.

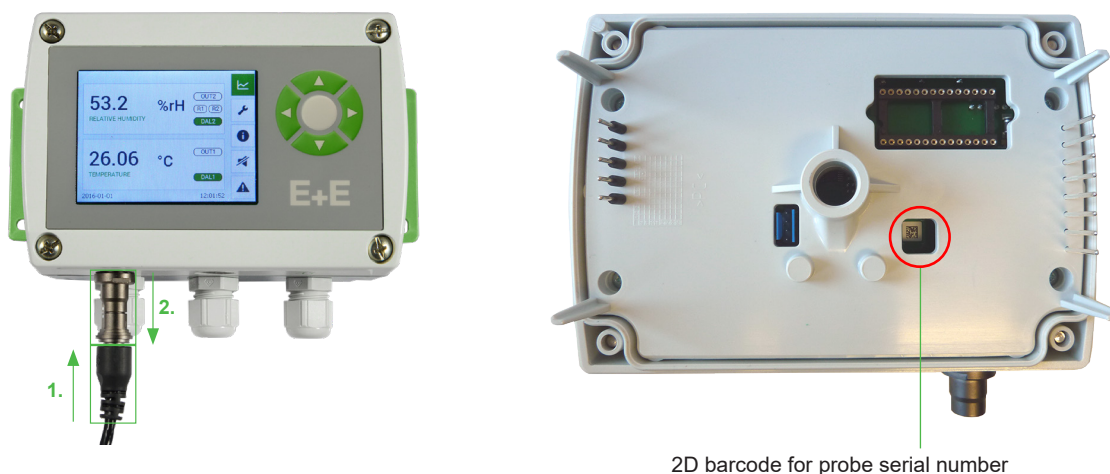

Fig. 18 Pluggable probe

Probe replacement procedure

1. Plug off the damaged probe
2. Plug on the new probe
3. Update the 7 parameters with PCS10 Product Configuration Software or via display and push buttons (see chapter 11 Appendix, Fig. 37 Device settings).

i PLEASE NOTE

When replacing the probe, the factory calibration loses its validity. A calibration to verify accuracy is recommended but not mandatory.

6 Setup and Configuration

The EE360 is ready to use and does not require any configuration by the user. The factory setup of EE360 corresponds to the type number ordered. For ordering guide please see datasheet at www.epluse.com/ee360. This chapter describes how to customize the device.

6.1 Configuration Interface

Factory setup can be changed by using a USB-A to micro USB-C cable and the PCS10 Product Configuration Software. The EE360 is powered by the PC via the USB interface, no additional power supply shall be applied.

The scaling of the analogue outputs, the settings of the alarm module, the digital settings can be changed and a T and RH adjustment can be performed.

In addition, it is possible to enable or disable the NAMUR error indication (factory setting: disabled).

The PCS10 offers a convenient graphical user interface for the moisture in oil sensor. To use the software for performing adjustments and changes in settings, please proceed as follows:

1. Download the PCS10 Product Configuration Software from www.epluse.com/pcs10 and install it on the PC.
2. Connect the EE360 to the PC using the Modbus configuration adapter.
3. Start the PCS10 software.
4. Follow the instructions on the PCS10 opening page for scanning the ports and identifying the connected device.
5. Click on the desired setup or adjustment mode from the main PCS10 menu on the left and follow the online instructions of the PCS10.



Fig. 19 USB serial interface



Fig. 20 Plugged USB cable and LED indication

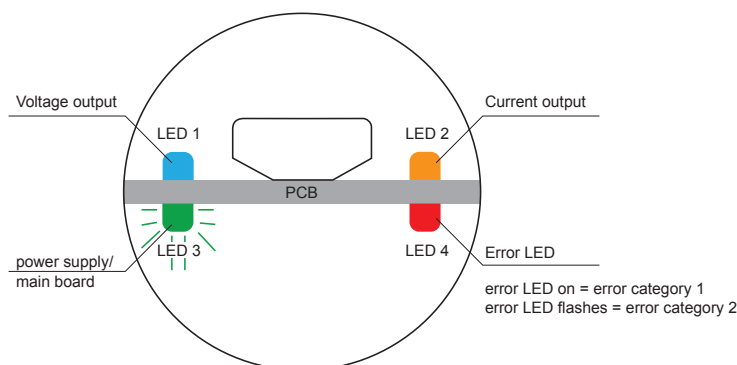

Fig. 21 Status LEDs are located at the USB port

NOTICE

Ensure that the device is only powered by the USB interface during firmware update, otherwise the update may fail.

6.2 3.5" TFT Colour Display (optional)

The EE360 display includes a data logger and push buttons for full configuration of the device. Upon start-up of an EE360 with display, the data logger and the configuration menu will be initialized during the first 5 seconds.

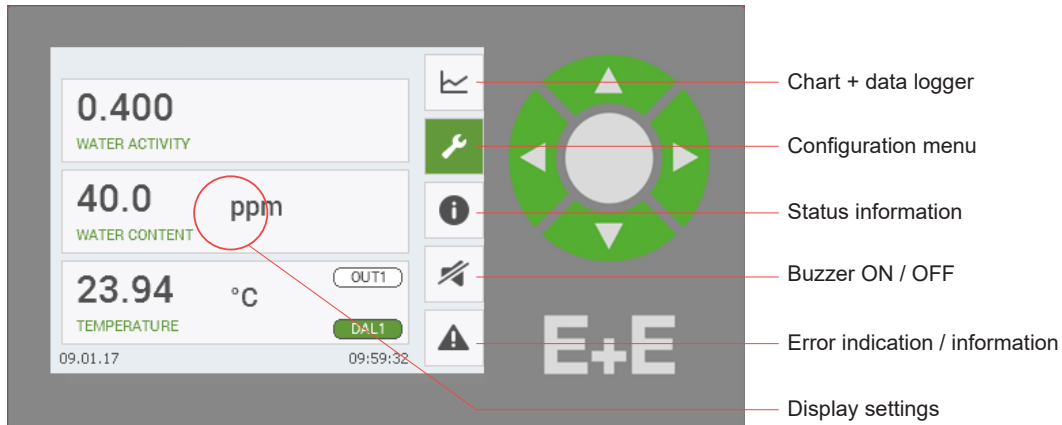

Fig. 22 Display with push buttons

6.3 Chart and Data Logger

The TFT display with the integrated data logging function saves all measured and calculated values to the internal memory. The data logger has a real time clock (UTC time) with a battery back-up.

NOTICE

Changing the UTC time erases all stored data.

The data logger can save 20 000 values for each measurand. The logging interval is user configurable from 1 second to 12 hours. The data logger menu is also used to select the data points that make up the graph and for scaling, see chapter 11 Appendix, Fig. 23 Data logging).

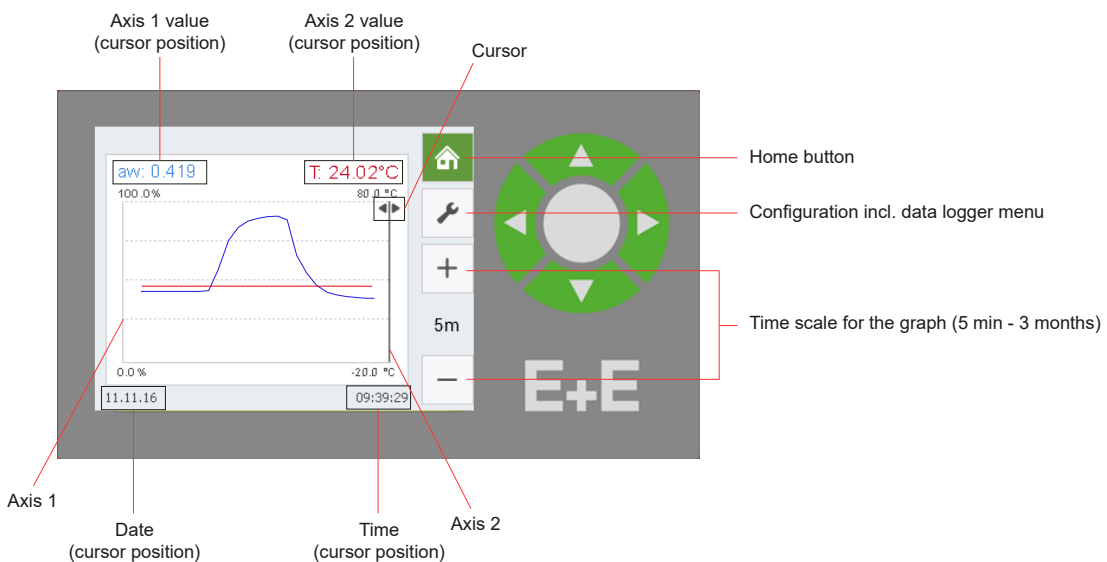

Fig. 23 Data logging

Each point in the graph represents a logged value. The points are connected by a linear interpolation.

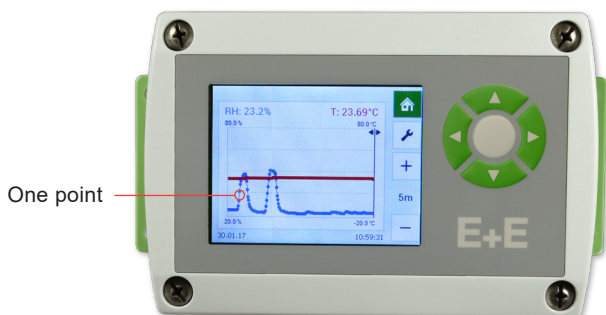

Fig. 24 Logging graph

The data logging continues even when the data memory is full; new data is stored while the oldest data is deleted (first in first out memory). The last 20 000 logged values are available in the internal memory.

The logged data can be downloaded with PCS10 Product Configuration Software as **.csv file** by choosing the measurands and the time period.

6.4 Configuration Menu

Detailed information to the configuration menu (see chapter 11 Appendix).

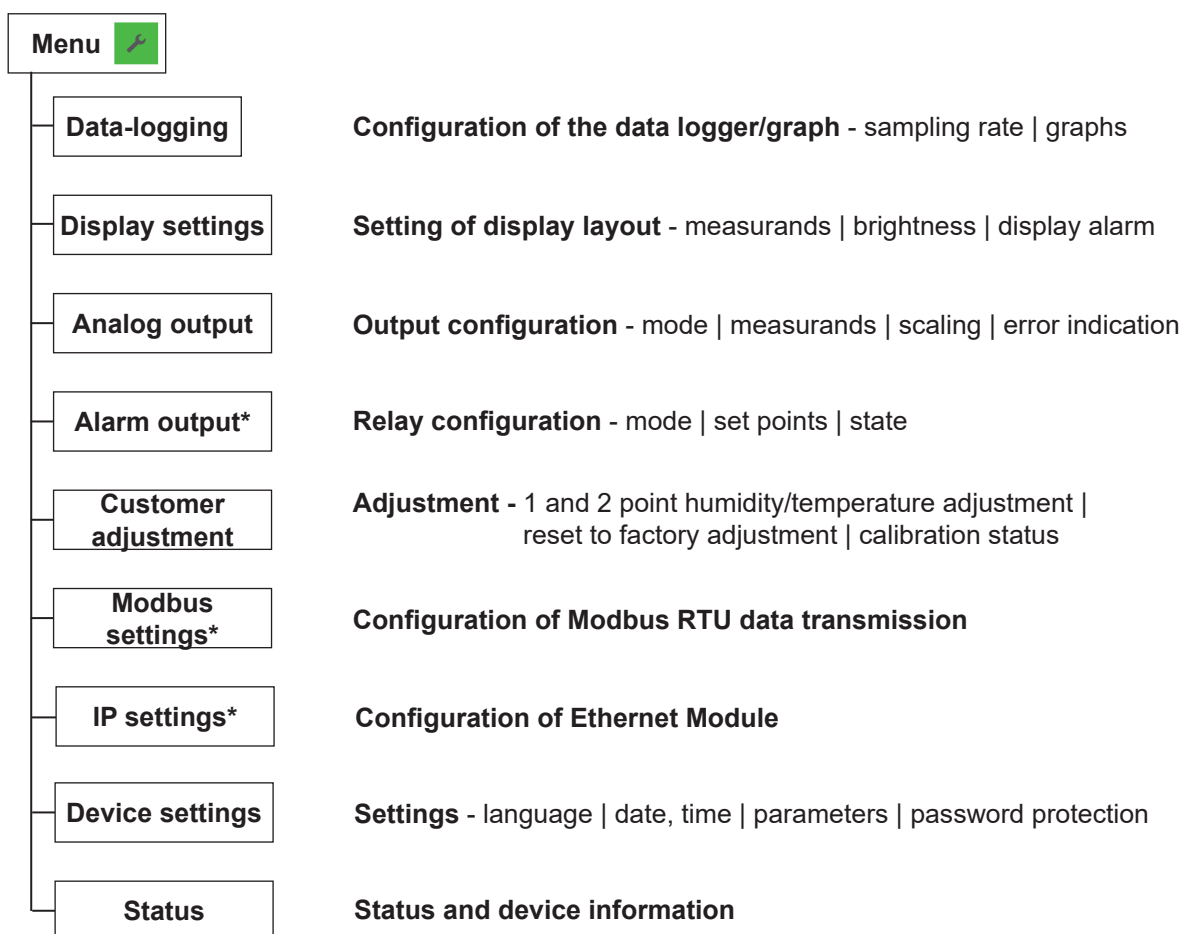

* Menu only available with the corresponding optional modules.

Fig. 25 Configuration Menu

6.5 Status Information

The status information shows all actual EE360 settings.

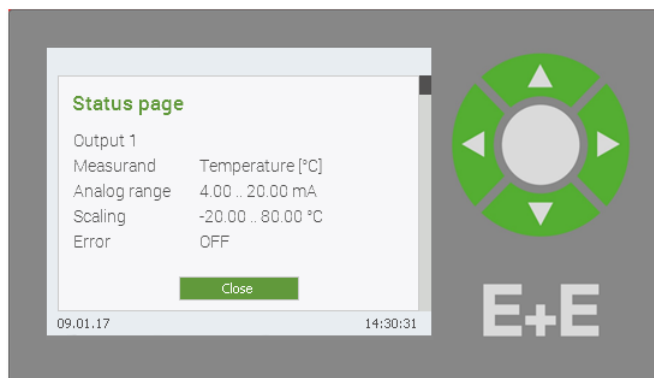



Fig. 26 Status information

6.6 Buzzer ON / OFF

Icon	Function
	Buzzer ON
	Buzzer OFF

Tab. 13 Explanation of the icons

6.7 Error Indication

When an error occurs, the error indication shows the error code.

7 Maintenance and Service

7.1 Self Diagnosis and Error Messages

7.1.1. Error Messages via Display

Error Description	Error Code (Display)	Error Category	Recommended Action
Voltage out short circuit - output 1 only*	1.1	1	Check the wiring of the outputs
Voltage out short circuit - output 2 only*	1.2		
Voltage out short circuit - both outputs*	1.3		
Current loop open - output 1 only	2.1		Check the wiring of the outputs
Current loop open - output 2 only	2.2		
Current loop open - both outputs	2.3		
RH sensor polluted	3.x	2	Clean the sensor
Hardware error	5.x		Return the faulty unit to E+E for service
	6.x		
	8.x		
Temperature measurement failure	7.x		
Humidity measurement failure	9.x		
	10.x		

* not available with 0 - 1 V output

Tab. 14 Overview of error codes

Error Category	Description
1	<p>Non-critical error, can be solved by the user.</p> <ul style="list-style-type: none"> The display blinks and the buzzer beeps every 10 seconds. The red status LED lights continuously.
2	<p>Critical error, return the device to E+E for service.</p> <ul style="list-style-type: none"> The display blinks and the buzzer beeps continuously. The red status LED flashes.

Tab. 15 Explanation of the error category

7.1.2. Error Messages via LEDs

Four status LEDs placed on both sides of a PCB are located close to the USB service interface, under a blind cover.

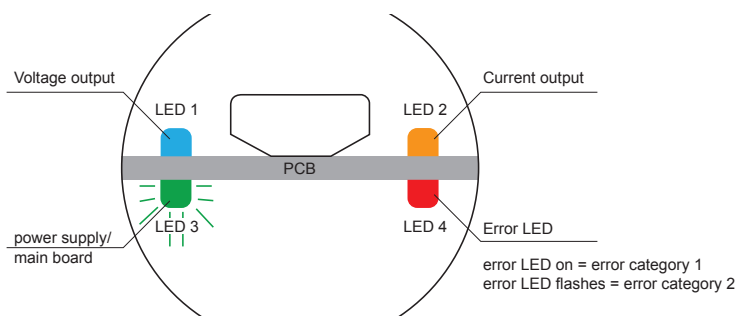

Fig. 27 Status LEDs

LED (Color)	Description
1 (blue)	Analogue output one set to voltage.
2 (orange)	Analogue output one set to current.
3 (flashing green)	Supply voltage applied (microprocessor is active).
4 (red)	<p>permanently lit</p> <p>flashes</p> <p>Error category 1</p> <p>Error category 2</p>

Tab. 16 Explanation of the LED colours

7.1.3. Solving Typical Problems

Error description	Likely causes and solutions
Display shows incorrect values	Error during re-adjustment of the sensor. → Reset to factory calibration and repeat the adjustment routine.
	Filter soiled → Replace filter
	Output configured incorrectly → Check configuration
Long response time	Filter soiled → Replace filter
	Inappropriate filter type → Contact E+E representative for advice.
High humidity values - red LED blinks	Water in sensing head → Investigate the cause for water / condensation. Contact E+E representative for advice.
	Inappropriate filter type → Contact E+E representative for advice.

Tab. 17 Self diagnosis

7.2 Sensor Replacement

A damaged capacitive humidity sensing element can be replaced by the user against an E+E replacement sensor (see chapter 8 Spare Parts and Accessories)

Sensor replacement procedure

1. Switch off supply voltage.
2. Loosen the lock of the filter cap with an appropriate tool (see Fig. 28 Loosen the lock of the filter cap).
3. Remove the filter cap from the tip of the probe with utmost care not to touch the sensors.
4. Solder off the damaged humidity sensing element.
5. Shorten the leads of the replacement sensor from 10 mm (0.39") to 6 mm (0.24").
6. Solder in the new humidity sensor, the active side shall face the temperature sensor.
7. Screw on a new filter cap with utmost care not to touch the sensors.
8. Bend the filter cap's locking mechanism to the inside.
9. Perform a 2-point humidity adjustment of the EE360 with the PCS10 Product Configuration Software or with the display and push buttons.

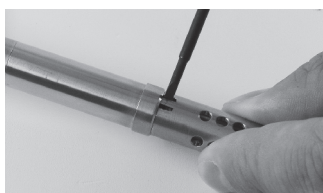

Fig. 28 Loosen the lock of the filter cap

NOTICE

- When replacing the humidity sensor element the factory calibration is not any longer valid.
- The humidity sensor element is an Electro Static Discharge (ESD) sensitive components and shall be handled as such.
- Hold the humidity sensor element only by the leads. Never touch the active surface of the sensor.

i PLEASE NOTE

The replacement of the humidity sensor element may be performed by qualified staff only. Since the performance of the instrument after the sensor exchange depends on the overall accuracy of the adjustment procedure, it is strongly recommended to return the device to E+E for sensor replacement.

7.3 Cleaning the Sensing Head and Filter Replacement

- If needed, the sensing head can be cleaned. For cleaning instructions please see www.epluse.com/ee360.

7.4 Moisture and Temperature Calibration and Adjustment

Depending on the application and the requirements of certain industries, there might arise the need for periodical humidity calibration (comparison with a reference) or adjustment (bringing the device in line with a reference)

The EE360 can be calibrated / adjusted with the help of the PCS10. For this purpose, the probe needs to be connected to a PC via a Modbus configuration adapter.

Definitions

- **Calibration** documents the accuracy of a measurement device. The device under test (specimen) is compared with the reference and the deviations are documented in a calibration certificate. During the calibration, the specimen is not changed or improved in any way.
- **Adjustment** improves the measurement accuracy of a device. The specimen is compared with the reference and brought in line with it. An adjustment can be followed by a calibration which documents the accuracy of the adjusted specimen.

Calibration and adjustment at E+E Elektronik

Calibration and/or adjustment can be performed in the E+E Elektronik calibration laboratory. For information on the E+E capabilities in ISO or accredited calibration please see www.eplusecal.com.

Calibration and adjustment by the user

i PLEASE NOTE

Moisture calibration and adjustment is to be carried out for the measurand “relative humidity” and shall be performed in air.

Depending on the level of accuracy required, the humidity reference can be:

- Humidity Calibrator (e.g. Humor 20), please see www.epluse.com/humor20.
- Handheld Device (e.g. Omniport30), please see www.epluse.com/omniport30.
- Humidity Calibration Kit (e.g. E+E Humidity Standards), please see www.epluse.com/ee360.

Perform 1 or 2-point adjustment via PCS10 Product Configuration Software or via display (see below).

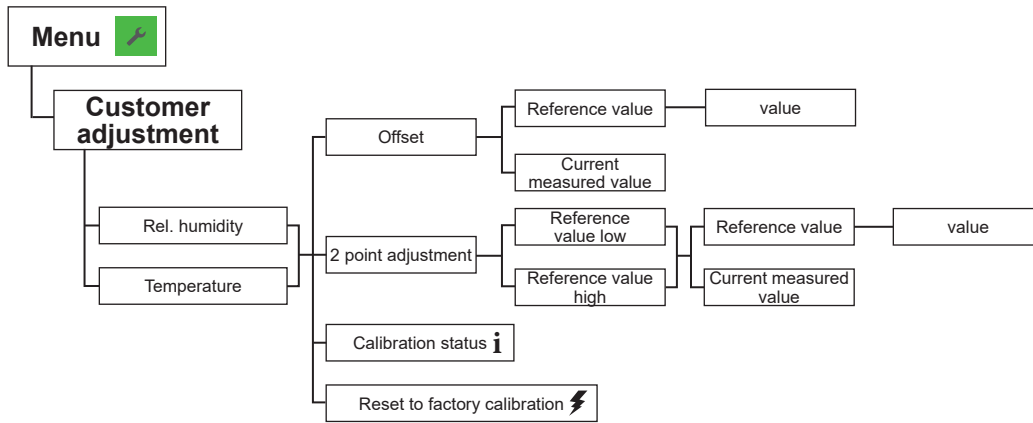

Fig. 29 Adjustment menu

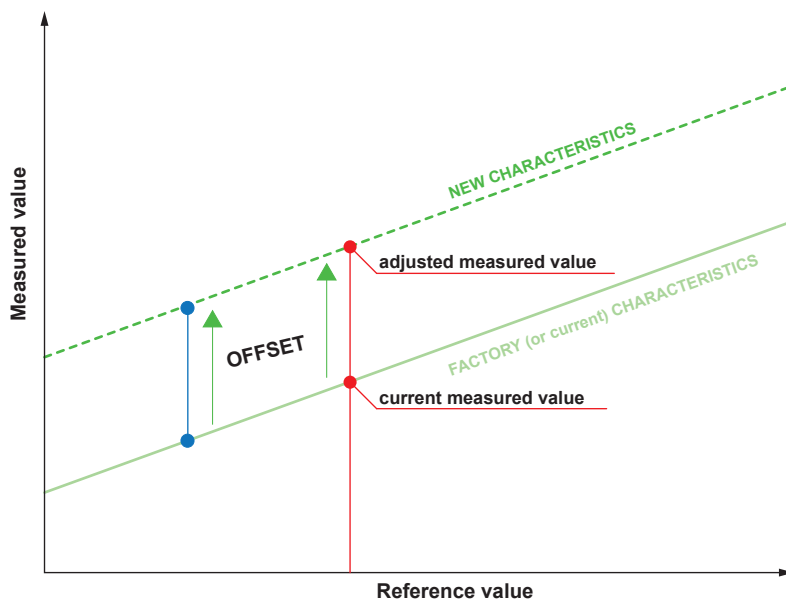

Fig. 30 Offset adjustment

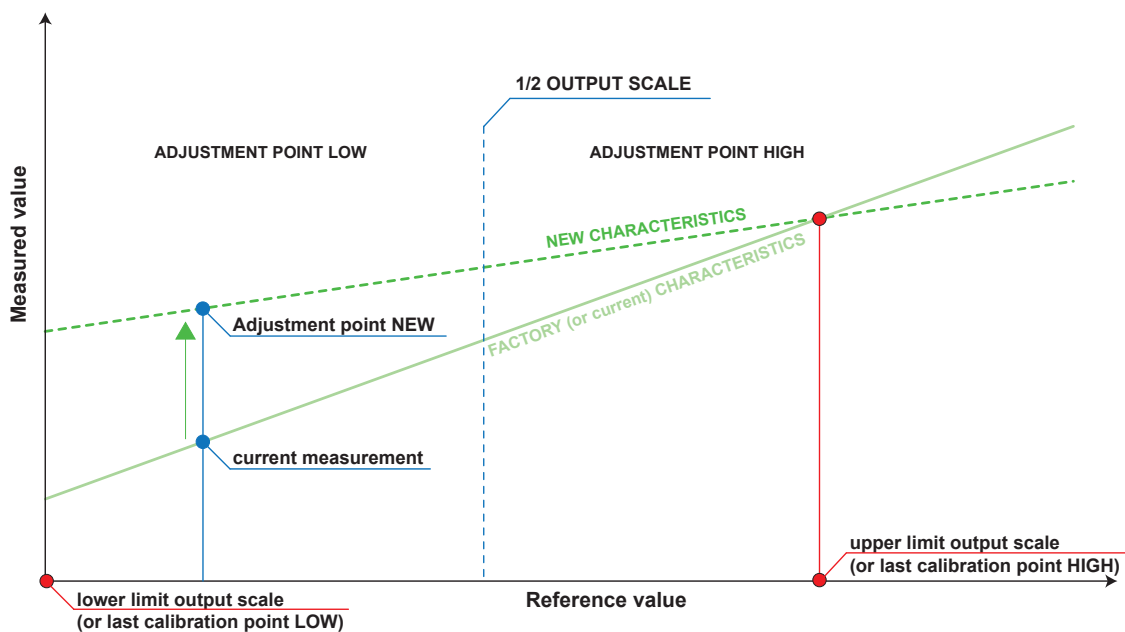

Fig. 31 2-point adjustment procedure

8 Spare Parts and Accessories

For further information please refer to the [Accessories](#) datasheet.

Description	Code
PCS10 Product Configuration Software (Free download: www.epluse.com/pcs10)	PCS10
Replacement filter cap	HA010110
Replacement probe ¹⁾	See chapter 5.7 Pluggable Probe (Option PC4)
Replacement humidity sensor	FE09
Bracket for DIN rail mounting ²⁾	HA010203
Investigation of oil specific parameters	ppm-cal
Humidity calibration kit	See datasheet Humidity Calibration Kit
RS485 kit for retrofitting	HA010605
Ball valve set 1/2" ISO	HA050101
Ball valve set 1/2" NPT	HA050104
Ethernet module for retrofitting polycarbonate enclosure	HA010606 for remote probe

1) Only for devices with pluggable probe option PC4.

2) For polycarbonate enclosure only. Two pieces are necessary for each EE360.

Ordering code for replacement probe

Feature	Description	Code	
Hardware Configuration		PE360-	
	Probe cable length	2 m (6.6 ft)	K2
		5 m (16.4 ft)	K5
		10 m (32.8 ft)	K10
	Probe length	100 mm (3.94")	L100
		200 mm (7.84")	L200
		400 mm (15.75")	L400
	Process connection	G1/2" ISO - sliding fitting, Ø13 mm (0.51")	PA23
		1/2" NPT - sliding fitting, Ø13 mm (0.51")	PA25

9 Technical Data

Measurands

Water Activity (aw) / Water Content (x)

Measuring range	0...1 aw 0...100 000 ppm; actual range depends on the oil type, for non-mineral transformer oil, specific solubility parameters are needed (ppm output is valid in the range 0...100 °C (32...212 °F))	
Accuracy¹⁾ -15...+40 °C (5...+104 °F) (0...0.9 aw) -15...+40 °C (5...+104 °F) (0.9...1 aw) -25...+70 °C (-13...+158 °F) -40...+180 °C (-40...+356 °F)	±(0.013 + 0.3%*mv) aw ±0.023 aw ±(0.014 + 1%*mv) aw ±(0.015 + 1.5%*mv) aw	mv = measured value
Temperature dependency of electronics, typ.	±0.0001 aw/°C (±5.6 * 10 ⁻⁵ aw/°F)	
Response time t₉₀, typ. @ 20 °C (68 °F) in still oil	10 min.	

- 1) Including hysteresis, non-linearity and repeatability, traceable to intern. standards, administrated by NIST, PTB, BEV...
The accuracy statement includes the uncertainty of the factory calibration with an enhancement factor k=2 (2-times standard deviation).
The accuracy was calculated in accordance with EA-4/02 and with regard to GUM (Guide to the Expression of Uncertainty in Measurement).

Temperature (T)

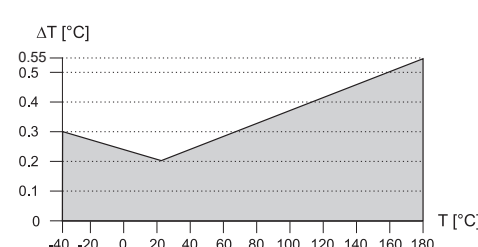
Probe measuring range	-40...+180 °C (-40...+356 °F)	
Accuracy¹⁾		
Temperature dependency of electronics, typ.	±0.005 °C/°C (±0.016 °F/°F)	

- 1) Traceable to international standards, administrated by NIST, PTB, BEV,...
The accuracy statement includes the uncertainty of the factory calibration with an enhancement factor k=2 (2-times standard deviation).
The accuracy was calculated in accordance with EA-4/02 and with regard to GUM (Guide to the Expression of Uncertainty in Measurement).

Outputs



Analogue

Two analogue outputs freely selectable and scalable	0 - 1 / 5 / 10 V 4 - 20 mA 3-wire 0 - 20 mA 3-wire	-1 mA < I _L < 1 mA R _L < 500 Ohm R _L < 500 Ohm	I _L = load current R _L = load resistance
--	--	---	---

Digital

Digital interface	RS485 (EE360 = 1 unit load)		
Protocol Factory settings Supported Baud rates Measured data types	Option J3	Modbus RTU 9 600 Baud, parity even, 1 stop bit, Modbus address 231 300, 600, 1200, 2400, 4800, 9600, 19200, 38400, 57600 and 76800 FLOAT32 and INT16	
Protocol	Option J4	Ethernet-PoE Modbus TCP	

General

Power supply class III  USA & Canada: Class 2 supply necessary, max. voltage 30 V DC	8 - 35 V DC 12 - 30 V AC 100 - 240 V AC, 50/60 Hz with Option AM3 ¹⁾
Current consumption , typ. @ 24 V DC/AC for 2 voltage outputs for 2 current outputs additional for display additional for Ethernet	15 mA and 40 mA _{rms} 35 mA and 100 mA _{rms} 50 mA and 150 mA _{rms} 30 mA and 90 mA _{rms}
Electrical connection	Screw terminals max. 1.5 mm ² (AWG 16)
Cable glands for polycarbonate enclosure for metal enclosure	M16x1.5, for cable Ø3 - 7 mm (0.12 - 0.28") M16x1.5, for cable Ø4.5 - 10 mm (0.18 - 0.39")
Pressure working range with pressure-tight probe	0.01...20 bar (0.15...300 psi)
Temperature range Operation Storage	-40...+60 °C (-40...+140 °F) without display -20...+50 °C (-4...+122 °F) with display
Material Probe Enclosure	Stainless steel 1.4404 (AISI 316L) PC (Polycarbonate), UL94-V0 approved Stainless steel 1.4404 (AISI 316L)
Protection rating	IP65 / NEMA 4X
Electromagnetic compatibility	EN 61326-1 EN 61326-2-3 Industrial environment FCC Part15 Class A ICES-003 Class A
Conformity	 
Two alarm outputs, with option AM2¹⁾	Changeover contact 250 V AC / 6 A 28 V DC / 6 A
Configuration software	E+E PCS10 Product Configuration Software Free download from www.epluse.com/pcs10

1) Degree of pollution 2, overvoltage category II, altitude up to 3000 m (9843 ft).

10 Conformity

10.1 Declarations of Conformity

E+E Elektronik Ges.m.b.H. hereby declares that the product complies with the respective regulations listed below:



European directives and standards.

and



UK statutory instruments and designated standards.

Please refer to the product page at www.epluse.com/ee360 for the Declarations of Conformity.

10.2 FCC Part 15 Compliance Statement

This equipment has been tested and found to comply with the limits for a Class A digital device, pursuant to part 15 of the FCC Rules. These limits are designed to provide reasonable protection against harmful interference when the equipment is operated in a commercial environment. This equipment generates, uses, and can radiate radio frequency energy and, if not installed and used in accordance with the instruction manual, may cause harmful interference to radio communications. Operation of this equipment in a residential area is likely to cause harmful interference in which case the user will be required to correct the interference at his own expense.

10.3 ICES-003 Compliance Statement

This Class A digital apparatus complies with Canadian ICES-003, Issue 5.

Cet appareil numérique de la classe A est conforme à la norme NMB-003 du Canada.

11 Appendix

11.1 Overview

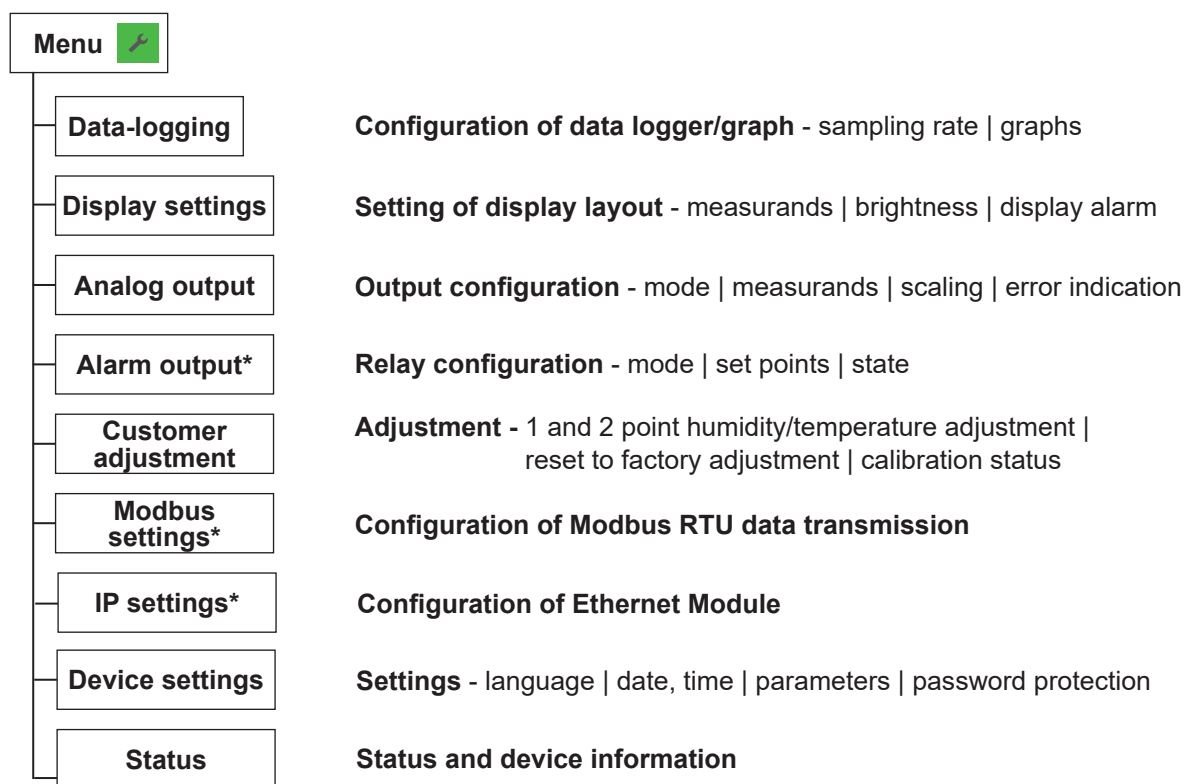

* Menu only available with connected modules.

Fig. 32 Menu overview

11.2 Detailed Information

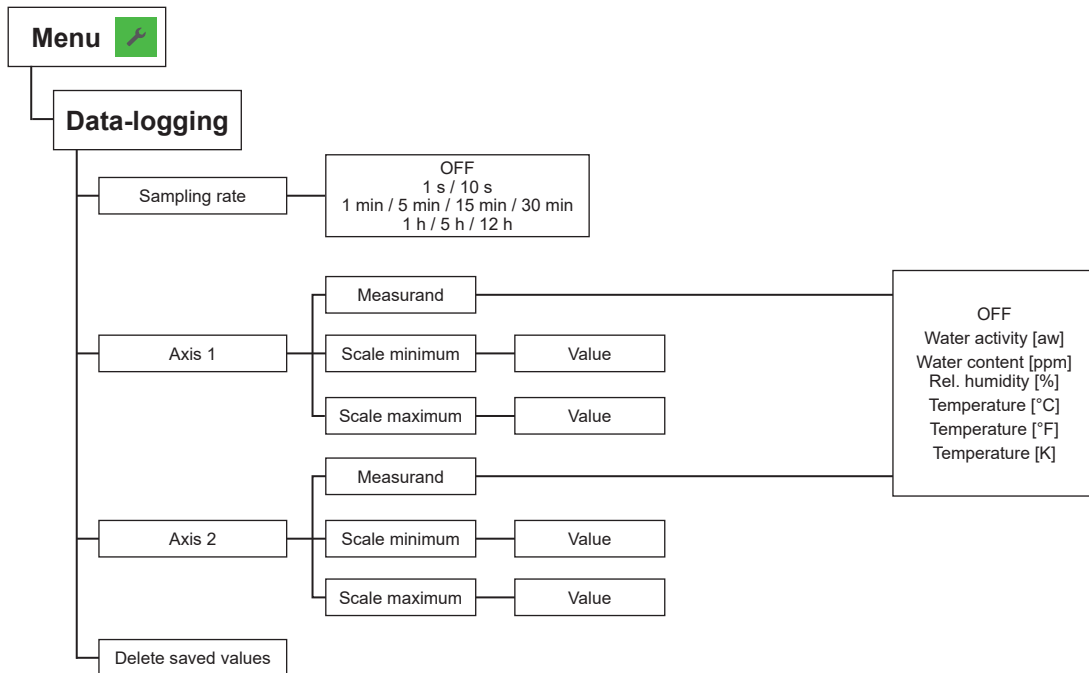

Fig. 33 Data logging

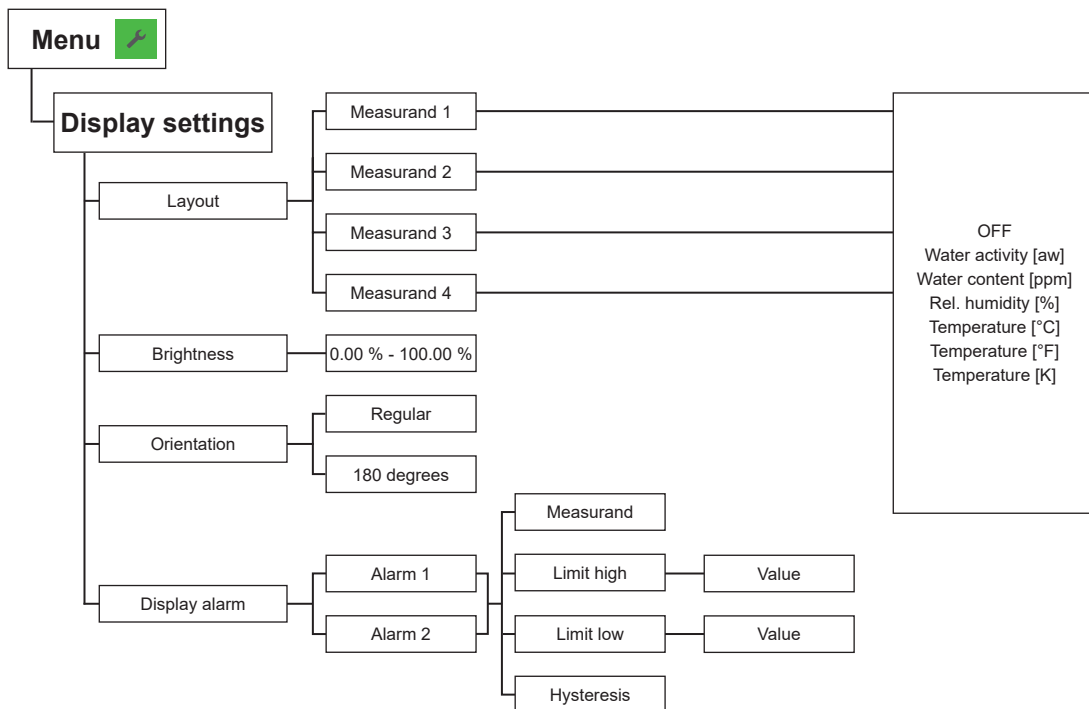

Fig. 34 Display settings

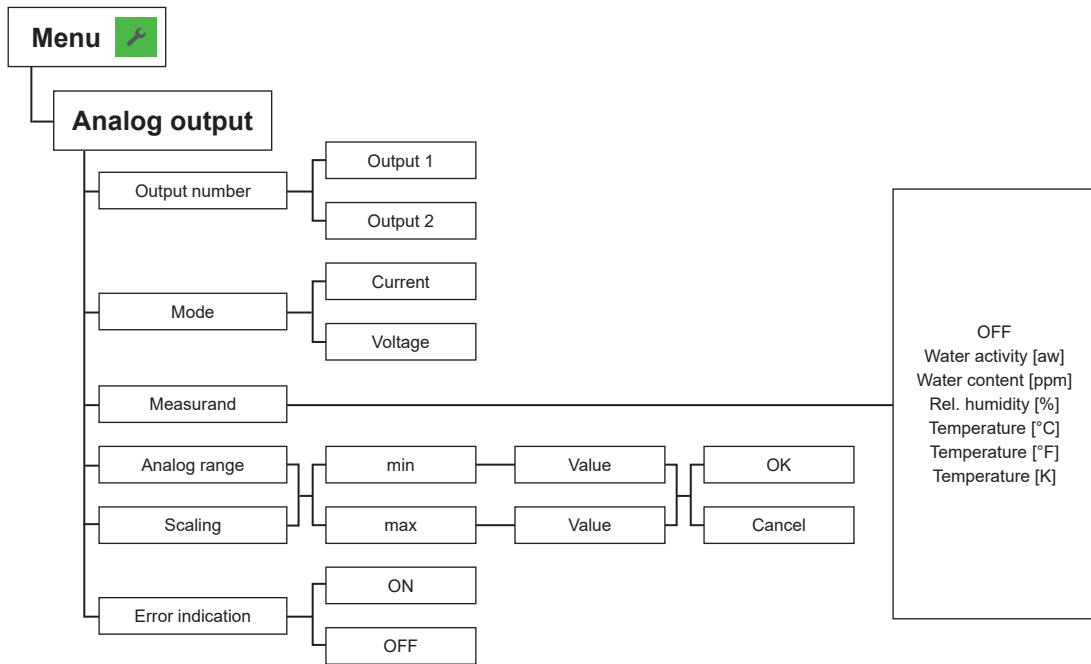

Fig. 35 Analogue output

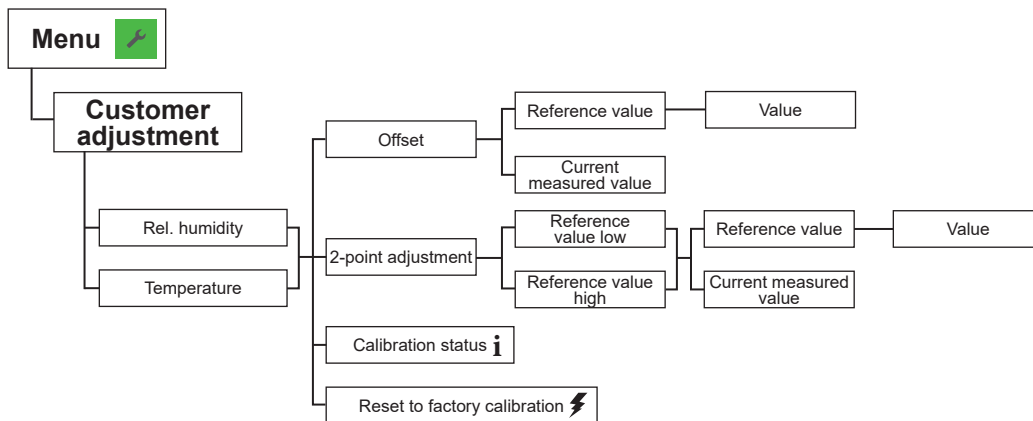
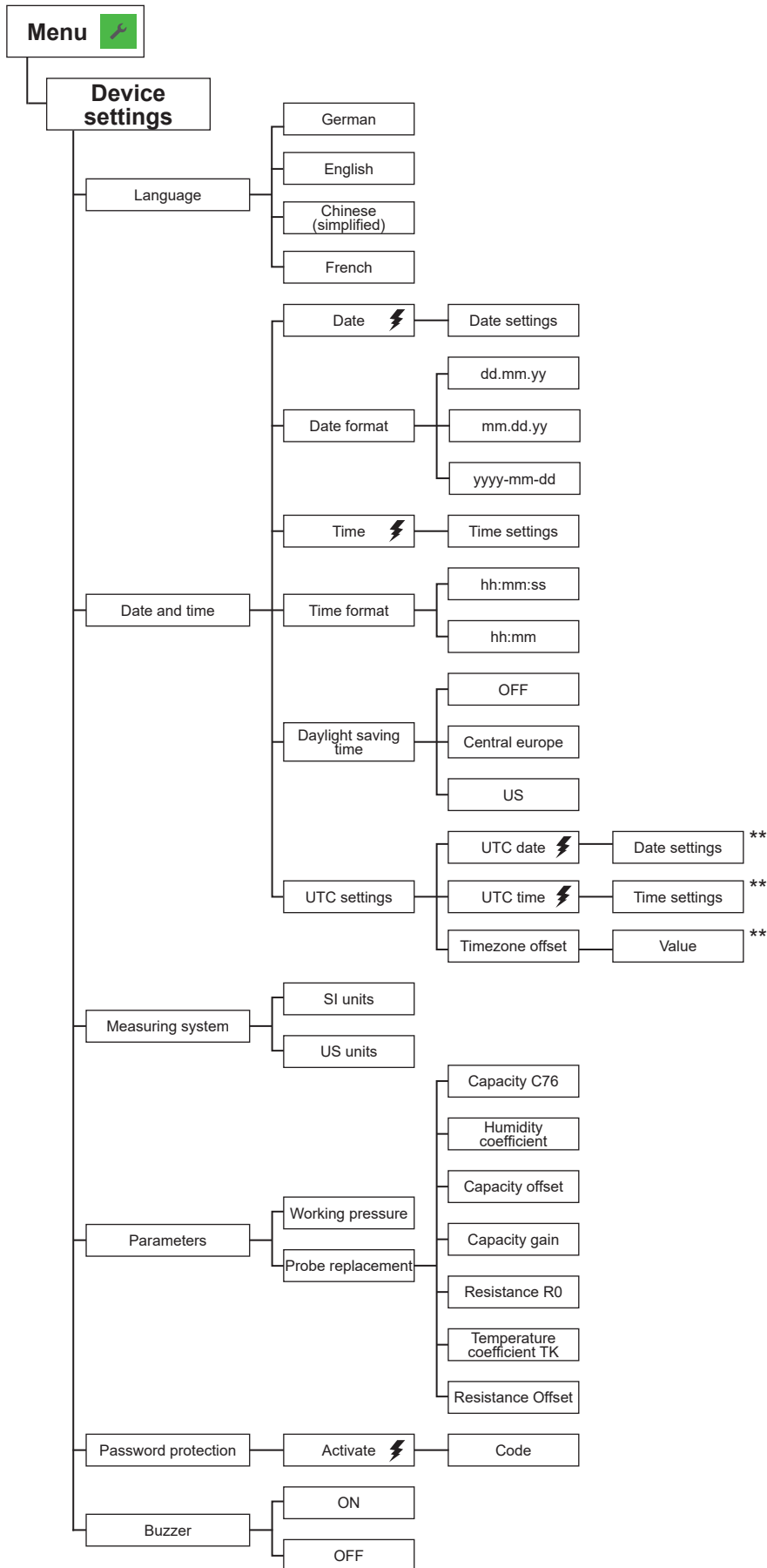

Fig. 36 Customer adjustment



** Changing the UTC time will delete measurement data!

Fig. 37 Device settings

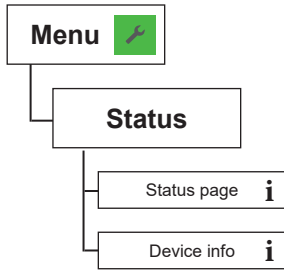

Fig. 38 Device settings

11.3 Optional Menus

Each of these menus is only available if the according module is plugged in during the start up procedure.

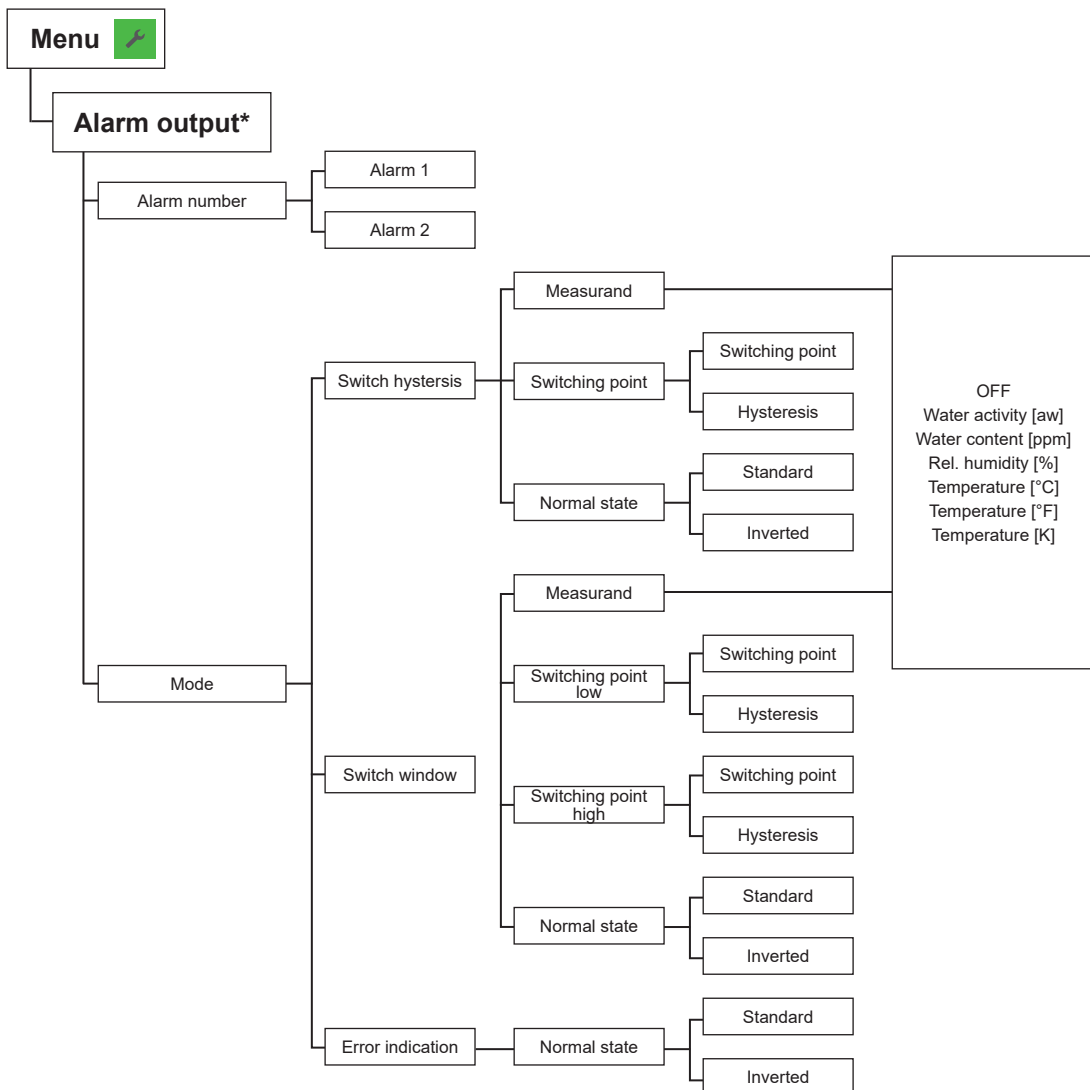
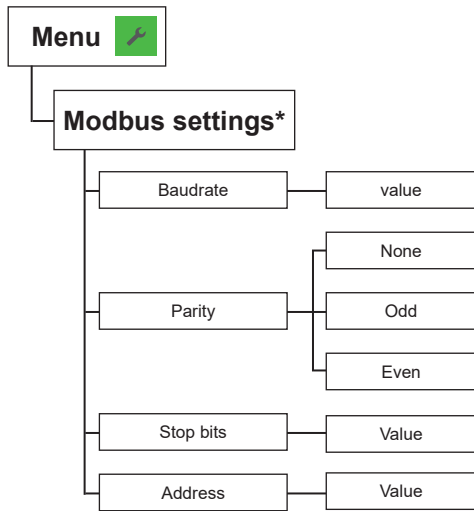

Fig. 39 Alarm output



* Menu only available with connected Modbus RTU module during EE360 start-up.

Fig. 40 Modbus settings

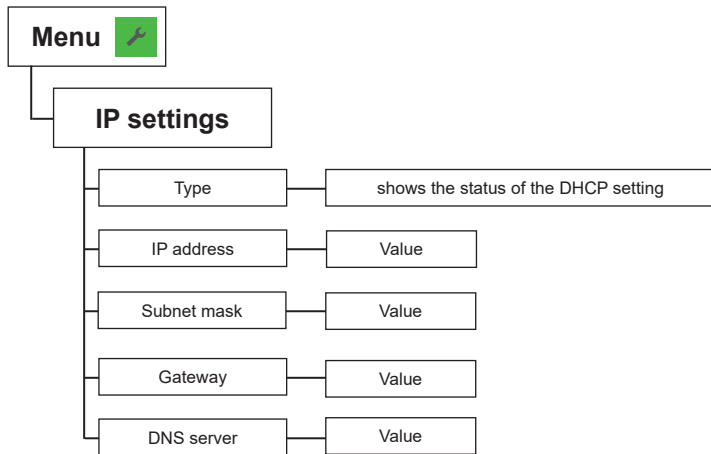
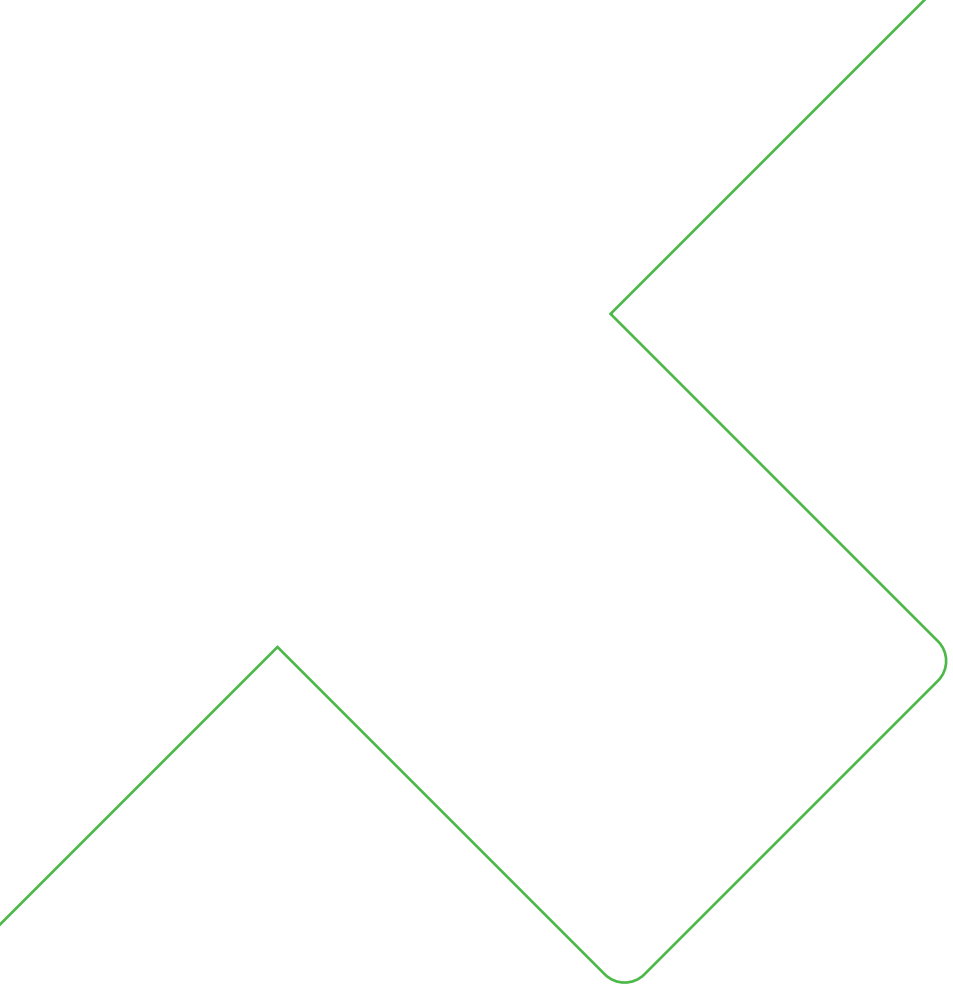

Fig. 41 IP settings



Company Headquarters &
Production Site

E+E Elektronik Ges.m.b.H.
Langwiesen 7
4209 Engerwitzdorf | Austria
T +43 7235 605-0
F +43 7235 605-8
info@epluse.com
www.epluse.com

Subsidiaries

E+E Sensor Technology (Shanghai) Co., Ltd.
T +86 21 6117 6129
info@epluse.cn

E+E Elektronik France SARL
T +33 4 74 72 35 82
info.fr@epluse.com

E+E Elektronik Deutschland GmbH
T +49 6171 69411-0
info.de@epluse.com

E+E Elektronik India Private Limited
T +91 990 440 5400
info.in@epluse.com

E+E Elektronik Italia S.R.L.
T +39 02 2707 86 36
info.it@epluse.com

E+E Elektronik Korea Ltd.
T +82 31 732 6050
info.kr@epluse.com

E+E Elektronik Corporation
T +1 847 490 0520
info.us@epluse.com



—
your partner
in sensor
technology.