



—
your partner
in sensor
technology.

+ User Manual EE741

**Inline Flow Sensor
for Compressed Air and Gases**



M-Bus

IO-Link

Content

1	General Information	3
1.1	Explanation of Warning Notices and Symbols	3
1.2	Safety Instructions	4
1.2.1.	General Safety Instructions	4
1.2.2.	Intended Use	4
1.2.3.	Mounting, Start-up and Operation	5
1.3	Environmental Aspects	5
2	Scope of Supply	5
3	Product Description	6
3.1	Modular Design	7
3.1.1.	Changing the Pipe Diameter	7
3.2	Functions	8
3.2.1.	General	8
3.2.2.	Analogue Output	9
3.2.3.	Digital Interface	10
3.3	Dimensions	10
3.3.1.	Installation Dimensions Gauge Mounting Block with Flanges	11
3.4	Display	11
4	Mounting and Installation	12
4.1	Choosing the Appropriate Mounting Location	12
4.1.1.	Process Pressure	12
4.2	Installation Position	13
4.3	Inlet and Outlet Measurement Path	14
4.4	Installation of the Gauge Mounting Block	15
4.4.1.	Operating the Pipeline without Sensing Unit	15
4.5	Mounting the Sensing Unit into the Gauge Mounting Block	16
5	Electrical Connection	17
5.1	Connection Diagram	17
5.1.1.	Switch and Pulse Outputs Internal Circuit	18
6	Setup and Configuration	19
6.1	Digital Interface	19
6.1.1.	M-Bus (Meter-Bus)	19
6.1.2.	Modbus RTU Register Map	20
6.1.3.	IO-Link	24
6.2	USB Configuration Interface	25
7	Display	25
7.1	Measured Value Display	26
7.2	Display Menu	26
8	Maintenance and Service	28
8.1	Error Messages	28
8.2	General Recommendations	28
8.3	Removal of the Sensing Unit from the Gauge Mounting Block	29
8.4	Cleaning the Sensing Head	29
8.5	Repairs	29
9	Accessories	30
10	Technical Data	30
10.1	Factory Setting of Outputs for DN15 / DN20 / DN25	32
10.2	Factory settings of the outputs DN32 / DN40 / DN50	33
10.3	Works Certificate	34
11	Conformity	35
11.1	Declarations of Conformity	35
11.2	FCC Part 15 Compliance Statement	35
11.3	ICES-003 Compliance Statement	35

1 General Information

This user manual serves for ensuring proper handling and optimal functioning of the device. The user manual shall be read before commissioning the equipment and it shall be provided to all staff involved in transport, installation, operation, maintenance and repair. E+E Elektronik Ges.m.b.H. does not accept warranty and liability claims neither upon this publication nor in case of improper treatment of the described products.

All information, technical data and diagrams included in this document are based on the information available at the time of writing. It may contain technical inaccuracies and typographical errors. The contents will be revised on a regular basis and changes will be implemented in subsequent versions. The described product(s) and the contents of this document may be changed or improved at any time without prior notice.

All rights reserved by E+E Elektronik Ges.m.b.H. No part of this document may be reproduced, published or publicly displayed in any form or by any means, nor may its contents be modified, translated, adapted, sold or disclosed to a third party without prior written permission of E+E Elektronik Ges.m.b.H.

PLEASE NOTE

Find this document and further product information on our website at www.epluse.com/ee741.

1.1 Explanation of Warning Notices and Symbols

Safety precautions

Precautionary statements warn of hazards in handling the device and provide information on their prevention. The safety instruction labeling is classified by hazard severity and is divided into the following groups:

DANGER

Danger indicates hazards for persons. If the safety instruction marked in this way is not followed, the hazard will very likely result in severe injury or death.

WARNING

Warning indicates hazards for persons. If the safety instruction marked in this way is not followed, there is a risk of injury or death.

CAUTION

Caution indicates hazards for persons. If the safety instruction marked in this way is not followed, minor or moderate injuries may occur.

NOTICE

Notice signals danger to objects or data. If the notice is not observed, damage to property or data may occur.

Informational notes

Informational notes provide important information which stands out due to its relevance.

INFO

The information symbol indicates tips on handling the device or provides additional information on it. The information is useful for reaching optimal performance of the device.

The title field can deviate from "INFO" depending on the context. For instance, it may also read "PLEASE NOTE".

1.2 Safety Instructions

1.2.1. General Safety Instructions

NOTICE

Improper handling of the device may result in its damage.

- The EE741 enclosure, the sensing probe and the sensing module shall not be exposed to unnecessary mechanical stress.
- Do not apply the supply voltage to the RS485 data lines.
- Use the EE741 only as intended and observe all technical specifications.

1.2.2. Intended Use

The inline flow sensor (device) is dedicated to the measurement of compressed air and non-corrosive and non-flammable gases in pipelines. Please consult E+E Elektronik if measurement shall be carried out in wet or filthy gases.

The inline flow sensor consists of a sensing unit and a gauge mounting block. The sensing unit may only be installed in the appropriate E+E gauge mounting block. It is not permissible to use the sensing unit without a gauge mounting block.

The EE741 inline flow sensor is designed for measurement in a pressurized system up to PN16 (16 bar / 230 psi).

The flow sensor may be operated only under the ambient conditions as defined in the technical data sheet. Use under other ambient conditions may lead to device malfunctions.

WARNING

Non-compliance with the product documentation may cause safety risk for people and the entire measurement installation and is therefore not permitted. The manufacturer may not be made liable for injuries damages caused by inappropriate or non-intended use or installation.

- It is not allowed to operate the EE741 in explosion hazard areas. When used with flammable gases, explosive atmospheres in the pipeline must be avoided at all times.
- The use of the flow sensor EE741 in any other way than described in this manual bears a safety risk for people and the entire measurement installation and is therefore not allowed.
- The manufacturer cannot be held responsible for damages as a result of incorrect handling, installation, and maintenance of the equipment.
- To avoid health risks or damage to the equipment, the installation should not be operated on with tools, which are not specifically mentioned or described in this manual.
- Excessive mechanical stress and inappropriate handling must be avoided.
- A short interruption of the flow using the measurement ball valve cannot be avoided when exchanging the sensing probe.
- The flow sensor can only be utilized in accordance with the conditions defined in the technical data. Otherwise, inaccuracies of the measurement will occur and equipment failures cannot be ruled out.
- For the safety of the user and for the functionality of the equipment the recommended steps by the manufacturer to put into operation, to test and to maintain should be taken and completed.

NOTICE

Failing to follow the instructions in this user manual may lead to measurement inaccuracy and device failures.

- The EE741 may only be operated under the conditions described in this user manual and within the specification included in chapter 10 Technical Data.
- Unauthorized product modification leads to loss of all warranty claims. Modification may be accomplished only with an explicit permission of E+E Elektronik Ges.m.b.H.!

1.2.3. Mounting, Start-up and Operation

The EE741 has been produced under state of the art manufacturing conditions, has been thoroughly tested and has left the factory after fulfilling all safety criteria. The manufacturer has taken all precautions to ensure safe operation of the device. The user must ensure that the device is set up and installed in a way that does not impair its safe use. The user is responsible for observing all applicable local and international safety guidelines for safe installation and operation of the device. This user manual contains information and warnings that must be observed by the user in order to ensure safe operation.

PLEASE NOTE

The manufacturer or his authorized agent can only be held liable in case of willful or gross negligence. In any case, the scope of liability is limited to the corresponding amount of the order issued to the manufacturer. The manufacturer assumes no liability for damages incurred due to failure to comply with the applicable regulations, operating instructions or the specified operating conditions. Consequential damages are excluded from the liability.

WARNING

Non-compliance with the product documentation may cause accidents, personal injury or property damage.

- Mounting, installation, commissioning, start-up, operation and maintenance of the device may be performed by qualified staff only. Such staff must be authorized by the operator of the facility to carry out the mentioned activities.
- The qualified staff must have read and understood this user manual and must follow the instructions contained within. The manufacturer accepts no responsibility for non-compliance with instructions, recommendations and warnings.
- All process and electrical connections shall be thoroughly checked by authorized staff before putting the device into operation.
- Do not install or start-up a device supposed to be faulty. Make sure that such devices are not used accidentally by marking them clearly as faulty.
- A faulty device shall be removed from the process.
- Service operations other than described in this user manual may only be performed by the manufacturer.

1.3 Environmental Aspects

PLEASE NOTE

Products from E+E Elektronik Ges.m.b.H. are developed and manufactured in compliance with all relevant environmental protection requirements. Please observe local regulations for the disposal of the device.



For disposal, the individual components of the device must be separated according to local recycling regulations. The electronics shall be disposed of correctly as electronics waste.

2 Scope of Supply

Item 1 - EE741

- Inline Flow Sensor for Compressed Air and Gases according to ordering guide
- 1x Allen key
- 1x USB cable
- User manual
- Inspection certificate according to DIN EN 10204-3.1

Item2 - Gauge mounting block

- Gauge mounting block incl. sealing plug

3 Product Description

The EE741 flow sensor operates on the thermal mass flow measurement principle and is suitable for measuring the flow of compressed air and gases in pipelines. It can be used for measuring the consumption of compressed air, nitrogen, argon, oxygen, CO₂ and other non-corrosive and non-flammable gases.

The EE741 measures the volume flow under standard conditions. The standard conditions according to DIN 1343 (1013.25 mbar; 0 °C) are factory-set. Additionally, the EE741 measures mass flow, standardized flow and temperature.

Depending on the ordered version, the EE741 is available either as analogue version with analogue output (current), switch output and/or pulse output for consumption metering or as digital version (Modbus RTU, M-Bus or IO-Link).

The analogue version has 2 configurable outputs, output 1 as current or switch output, output 2 as switch or pulse output.

The digital version provides Modbus RTU, M-Bus or IO-Link interface by factory.

The EE741 features an integrated consumption meter. The consumption volume can be shown on the display and is retained even if the supply voltage is interrupted.

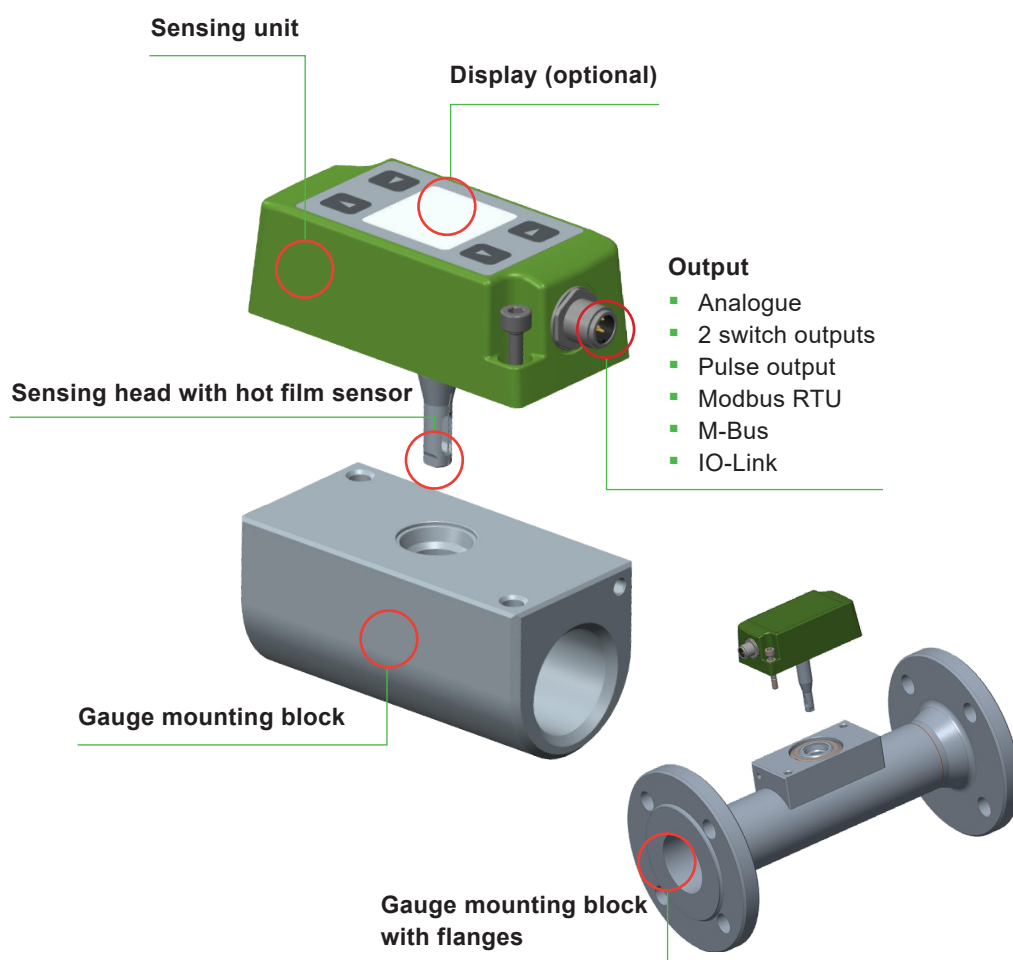

Fig. 1 Components

3.1 Modular Design

One and the same sensing unit can be used for each of three pipe diameters:

Pipe diameter	Pipe diameter
EE741	EE741-N50 can be operated optionally with a gauge mounting block with flanges.
DN15 (1/2")	DN32 (1-1/4")
DN20 (3/4")	DN40 (1-1/2")
DN25 (1")	DN50 (2")

Tab. 1 Part description

The pipe diameter is easily changed via the display menu or the EE-PCS Product Configurator Software (available for free download at www.epluse.com/configurator).

In the diameters DN32 (1-1/4") / DN40 (1-1/2") / DN50 (2") the EE741-N50 can be operated optionally with a gauge mounting block with flanges.

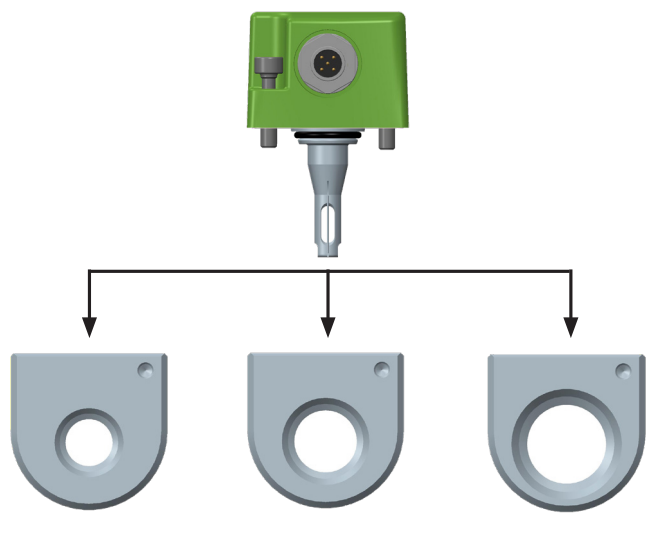

Fig. 2 EE741 Sensor for three different pipe diameters

Once the gauge mounting block is built into the pipeline, the sensing unit can be installed and removed without disassembly of pipework. As a result, the EE741 is also ideal for temporary measurement at several mounting blocks. The sealing plug included in the scope of supply enables the normal operation of the compressed air system when the sensing unit is removed.

3.1.1. Changing the Pipe Diameter

i PLEASE NOTE

Upon delivery, the factory setting of the sensing unit corresponds to the pipe diameter as ordered. The setting must match the gauge mounting block. For use with a gauge mounting block of different diameter, the sensing unit setting shall be changed correspondingly, otherwise relevant measurement errors have to be expected.

Pipe diameter label



Fig. 3 Pipe diameter on gauge mounting block

Pipe diameter label



Fig. 4 Pipe diameter on gauge mounting block with flanges

The pipe diameter setting of the sensing unit can be viewed and changed using the EE-PCS Product Configurator Software and via the IO-Link interface.

On the optional display, the pipe diameter setting of the sensing unit can be viewed on the status page and can be changed using the “Pipe diameter” menu. For further information see chapter 7 Display.

3.2 Functions

3.2.1. General

Maximum consumption value on the display

The consumption value on the display is limited at 999 999 999.0 m³. For value above this, the display shows “LCD maximum”, while internally the consumption is metered normally up to the maximum value of 3.4 * 10³⁸ m³. Values above 999 999 999.0 m³ can be read with the EE-PCS Product Configurator Software.

Setting the Standard Conditions

The standardized volume flow calculation is based on the standard conditions stored in the EE741 sensing unit. The factory setting for the standard conditions complies with DIN 1343:
pn = 1013.25 mbar (14.7 psi); Tn = 0 °C (32 °F)

The standard conditions can be changed via display menu, via EE-PCS Product Configurator Software or via IO-Link.

Low Flow Cut-Off

Very small (insignificant) flow values can be suppressed by setting a shutdown threshold.

Measured values below the shutdown threshold have no effect on the output signal, display and consumption meter.

The minimum shutdown value can be set in m³/h or ft³/min.

3.2.2. Analogue Output

Current Output (OUT 1)

The analogue current output (factory setting 4 - 20 mA or 0 - 20 mA) is used for the actual flow or temperature measured values. The analogue output is freely configurable and scalable via the display menu or the EE-PCS Product Configurator Software.

i PLEASE NOTE

The analogue output features an error message function according to NAMUR NE43. In the event of a faulty sensing head, the output signal will freeze at 21 mA.

Switch (Alarm) Outputs (OUT 1 and OUT 2)

The switch outputs can be set via the display menu or via the EE-PCS Product Configurator Software. One can select between “hysteresis mode” or “window mode” as well as between normally closed (NC) or normally open (NO) contact.

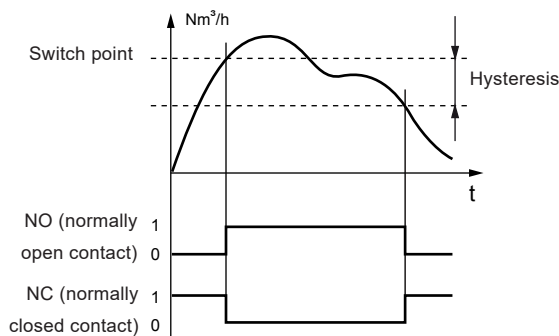

Fig. 5 Hysteresis mode

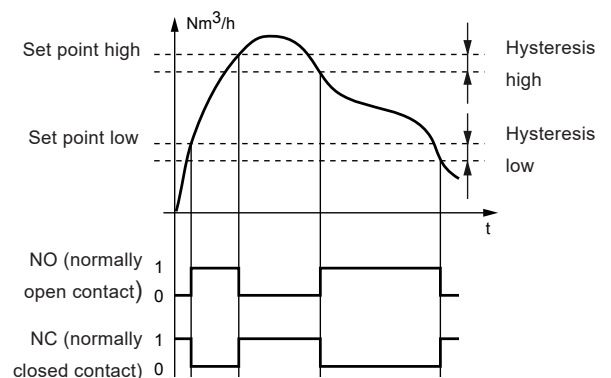

Fig. 6 Window mode

Pulse Output (OUT 2) and Consumption Meter

The EE741 flow sensor features an integrated meter with pulse output, which totalizes the consumption of compressed air or gas.

With the display menu or the EE-PCS Product Configurator Software, the user can set:

- Pulse duration: 0.02...2 s
- Pulse value: 0.1...1 000 m³

The pulse - pause ratio must be at least 1:2. This means that the time between pulses must be at least twice the pulse duration.

The minimum time between two pulses is 2 s.

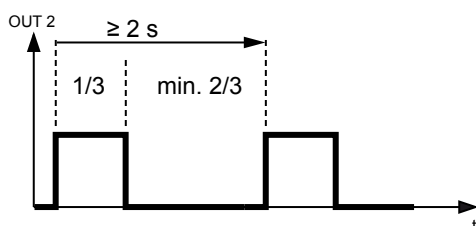

Fig. 7 Pulse-pause ratio

The pulse duration and the pulse value can be calculated with following MIN/MAX-Formula:

Calculation of the minimum “pulse value” or the maximum “pulse duration”.

$$\text{IMPW_MIN} = \text{NORMV_MAX} [\text{m}^3/\text{h}] * \text{IMPL} [\text{s}] / 1200$$

$$\text{IMPL_MAX} = \text{IMPW} [\text{m}^3] * 1200 / \text{NORMV_MAX} [\text{m}^3/\text{h}]$$

Short Form	Description
IMPW	Pulse value [m ³]
IMPL	Pulse duration [s]
IMPW_MIN	Minimum value for pulse value [m ³]
IMPL_MAX	Maximum pulse duration [s]
NORMV_MAX	Maximum expected standardized volume flow [m ³ /h]

Tab. 2 Explanation of abbreviations

The totalized consumption is stored every minute and is retained even if the supply voltage is interrupted.

The totalized consumption can be shown on the display. A reset of the consumption meter can be performed via the display menu or the EE-PCS Product Configurator Software.

3.2.3. Digital Interface

The EE741 is available in three different digital interface versions, with Modbus RTU, M-Bus or IO-Link interface. The Modbus RTU and M-Bus interface parameters can be accessed and changed with the help of the EE-PCS Product Configurator Software.

3.3 Dimensions

Values in mm (inch)

EE741

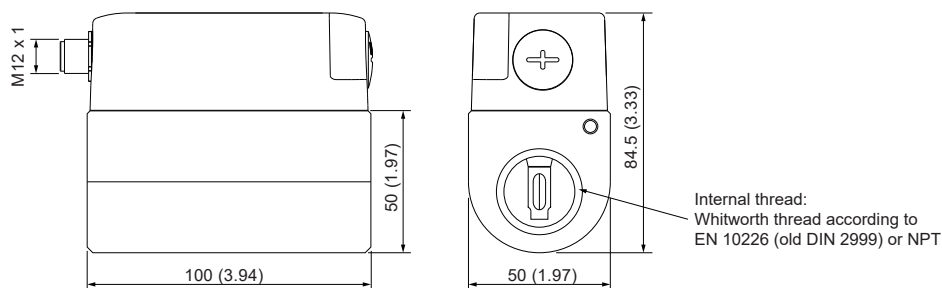

EE741-N50

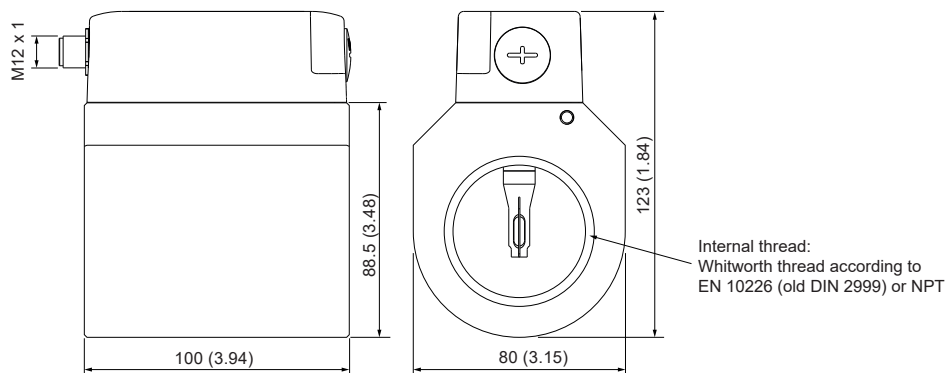

Gauge mounting block	Thread Rp or NPT
DN15	1/2"
DN20	3/4"
DN25	1"
DN32 ¹⁾	1...1/4"
DN40	1...1/2"
DN50	2"

1) Only Rp thread

Tab. 3 Gauge mounting blocks with matching threads

3.3.1. Installation Dimensions Gauge Mounting Block with Flanges

EE741-N50

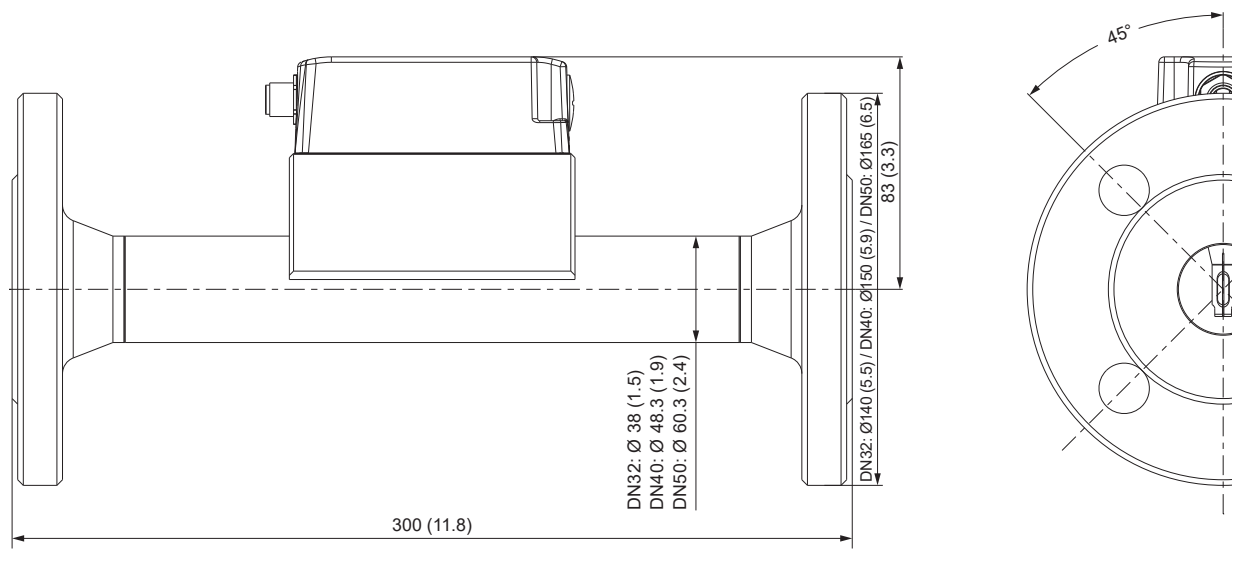

3.4 Display

The EE741 features an optional LC display showing the actual measured values and the overall consumption. The complete device setup and configuration can be performed with the control keys and intuitive, self explanatory menu navigation.

Please refer to chapter 7 Display for details.

4 Mounting and Installation

4.1 Choosing the Appropriate Mounting Location

PLEASE NOTE

- The mounting location site shall be easily accessible and free of vibration.
- A minimum clearance of 150 mm (5.9") shall be observed around the mounting location for installing / removing the sensing unit of the EE741.
- The ambient temperature shall not exceed the specified limits. Also consider the possible heat radiation.
- Air (medium) purity at the mounting location shall comply to ISO 8573-1:2010, at least Class 3.4.4.
- The medium and the ambient conditions at the mounting location shall be non-condensing.
- In compressed air networks, the EE741 shall be installed after the air dryer. In the absence of a dryer, the EE741 shall be installed after the condensate separator and appropriate filters.
- The flow direction in the pipe has to be observed.
- The recommended inlet and outlet path length has to be observed. These are relevant for measurement accuracy as specified in the EE741 data sheet.
- EE741 shall be located as far as possible from flow disturbances, for instance at an appropriate distance before valves.

4.1.1. Process Pressure

WARNING



Pressurized and especially overpressurized pipes may lead to dangerously accelerated parts. This can lead to serious injuries to personnel.

- The pressure in the pipeline may not exceed 16 bar (232 psi).
- In order to install or remove the measurement section the pipeline system should be depressurized.

Due to its measuring principle, the measurement accuracy of the EE741 is quasi-independent of the actual process pressure. Besides, the device is factory adjusted at 7 bar (102 psi) absolute pressure. For normal requirements pressure compensation is not necessary. For best measurement accuracy, the actual working pressure can be set via display menu, via EE-PCS Product Configurator Software or via the IO-Link interface.

4.2 Installation Position

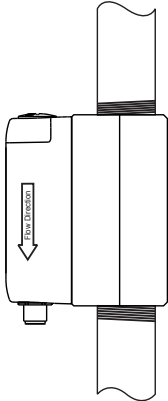
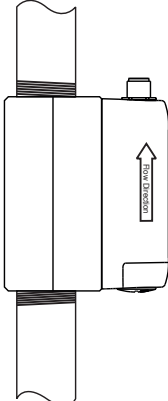
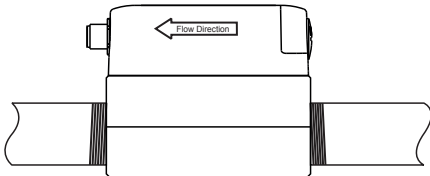
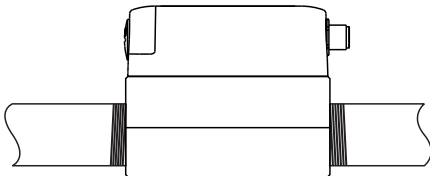
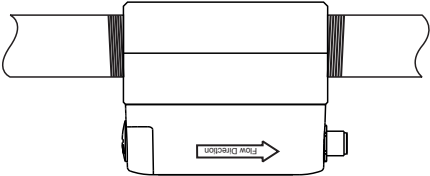
The suitability of the following mounting positions must be taken into account for mounting the EE741 in the gauge mounting block or in the gauge mounting block with flanges.

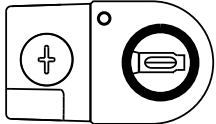
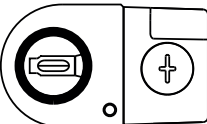
Mounting		Position
Vertical		
		+
Horizontal, sensor upwards		
		+
Horizontal, sensor downwards		
		-
Horizontal mounting, sensor across		
		+

+ ... Recommended installation position
 - Not recommended

Tab. 4 Sensor positions

4.3 Inlet and Outlet Measurement Path

For measurement accuracy according to product specification, the EE741 flow sensor shall be located as far as possible from flow disturbances caused for instance by pipe reductions or expansions, bends, T pieces, valves or sliders. This can be accomplished by observing a minimum inlet and outlet path length, which depends on both the nature of disturbance and the pipe diameter. This applies to mounting the EE741 in the gauge mounting block as well as in the gauge mounting block with flanges.

- The flow sensor shall be located before valves or sliders.
- With lighter gases the inlet paths need to be extended.

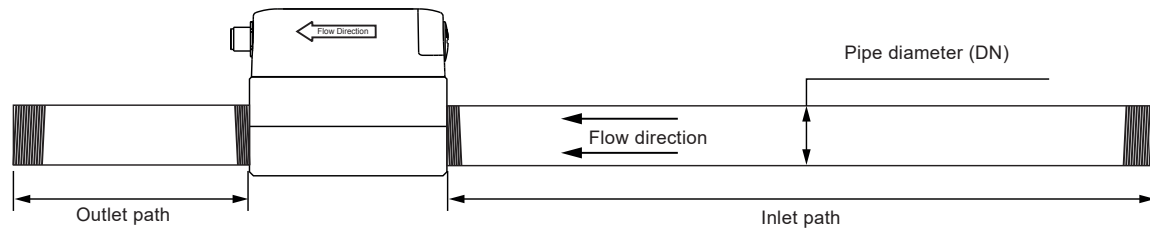



Types of pipes		DN = Nominal Pipe Size	
		Inlet path	Outlet path
	Extension	15 x DN	5 x DN
	Reduction	15 x DN	5 x DN
	90° - elbow	20 x DN	5 x DN
	Two 90° - elbows, in one level	25 x DN	5 x DN
	Two 90° - elbows, in two levels, T-piece	30 x DN	5 x DN
	Valve, slider	50 x DN	5 x DN

Fig. 8 Optimal conditions for achieving the specified measuring accuracy

4.4 Installation of the Gauge Mounting Block

4.4. Gauge Mounting Block

WARNING

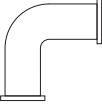
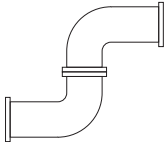
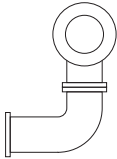
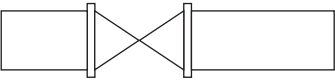
The gauge mounting block is symmetrical and can be installed in the pipeline irrespective of the flow direction.

- All connections must be properly sealed and checked for tightness.
- The thread seals must not affect the cross-section of the pipe or the block.

4.4. Gauge Mounting Block with Flanges

WARNING

The gauge mounting block with flanges is symmetrical and can be installed in the pipeline irrespective of the flow direction. The entire media contacting surface is of stainless steel 1.4404.

- Both connection surfaces of the flanges are to be connected to the pipe system with suitable seals (see HA074532, HA074540, HA074550).
- The seals must not impact the cross section of the pipe or of the block.
- All connections must be properly sealed and checked for tightness before use.

4.4.1. Operating the Pipeline without Sensing Unit

To operate the pipeline without the sensing unit, the opening of the gauge mounting block which accommodates the sensing head can be closed using the sealing plug included in the scope of supply (Fig. 9). The sealing plug has a Tuflok® coating (www.bossard.com) and does not require any additional seal. The sealing plug has to be mounted with a torque of min. 28 Nm.

Under normal operation with sensing unit installed, the sealing plug shall be placed for safe keeping into the opening at the side of the gauge mounting block (Fig. 10).



Fig. 9 Gauge mounting block with sealing plug



Fig. 10 Sealing plug in park position



Fig. 11 Gauge mounting block with flanges with sealing plug

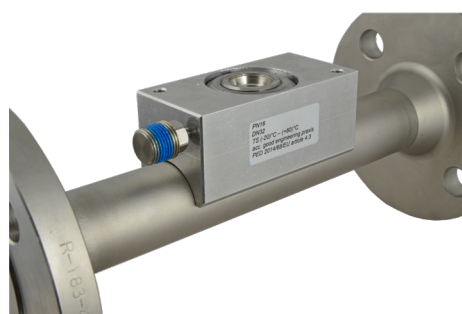

Fig. 12 Gauge mounting block with flanges with sealing plug in park position

4.5 Mounting the Sensing Unit into the Gauge Mounting Block

WARNING

Depressurize the pipeline before mounting or removing the sensing unit.

1. In case the gauge mounting block has been operated without sensing unit, remove the sealing plug with a WAF 13 spanner.
2. Remove the protective cap from the sensing head (Fig. 13) and insert carefully the sensing head of the sensing unit into the gauge mounting block.

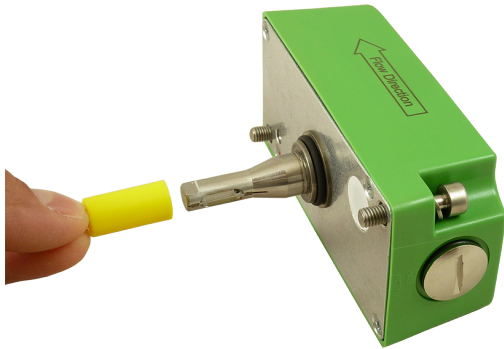

Fig. 13 Remove protective cap

3. Make sure that the direction arrow on the sensing unit corresponds to the flow direction in the pipeline. Failure to comply with this may lead to additional measurement error of $\pm 3\%$ of the measured value.
4. Complete the mounting by tightening the mounting screws with a max. torque of 6 Nm using the 4 mm hex key included in the scope of supply (Fig. 14).



Fig. 14 Tighten mounting screws

5 Electrical Connection

NOTICE

Before electrical connections are made, the power supply must be turned off first. If not observed, the electronics can be damaged as a result. Only a qualified electrotechnical engineer may install the device.

Observe all applicable national and international requirements for the installation of electrical devices as well as power supply according to EN 50178, SELV, PELV.

5.1 Connection Diagram

⚠ WARNING

Incorrect installation, wiring or power supply may cause overheating and therefore personal injuries or property damage.

- For correct cabling of the device, always observe the presented wiring diagram for the product version used.
- The manufacturer cannot be held responsible for personal injuries or property damage as a result of incorrect handling, installation, wiring, power supply or maintenance of the device.



Fig. 15 M12x1 connector

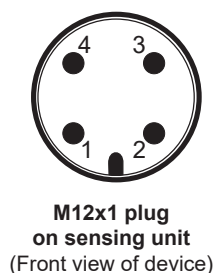

Pin	Analogue / switch / pulse output	Modbus RTU	M-Bus	IO-Link
1	V+	V+	V+	V+ (L+)
2	Output 1	RS485 A (=D+)	M-Bus	NC
3	GND	GND	GND	GND (L-)
4	Output 2	RS485 B (=D-)	M-Bus	CQ

5.1.1. Switch and Pulse Outputs Internal Circuit

Switch and pulse outputs are NOT potential-free and include internal pull-down resistors (Fig. 16).

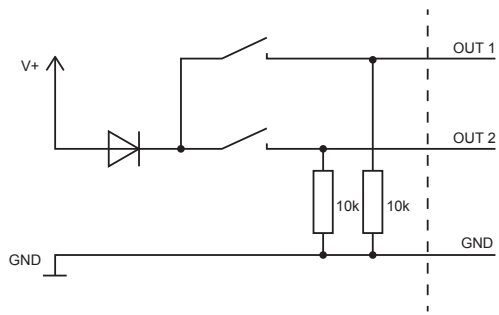

Fig. 16 Switch / pulse output

6 Setup and Configuration

6.1 Digital Interface

6.1.1. M-Bus (Meter-Bus)

The M-Bus (Meter-Bus) is a field bus for recording consumption data. Transmission runs serially on a reverse polarity protected two-wire line. The EE741 flow sensor as M-Bus address requires a separate supply voltage. There is no prescribed specific topology (line or star) for the wiring. Normal phone cable of type J-Y(St)Y Nx2x0.8 mm can be used. The max. cable length per segment (primary addressed) is 250 m (820 ft).

The table below shows the package structure of the measurement/consumption data sent by the EE741 sensor:

Header	
68	Start of the telegram
4F 4F	L-field (length)
68	Second starting signal
08	C-field (RSP_UD)
XX	A-field (address)
Start User Data	
72	CI-field (variable data structure)
XX XX XX XX	Identification number
A5 16	Manufacturer (0x16A5 ... EUE)
01	Version
09	Medium (9 ... compressed air)
XX	Access number (consecutive)
00	Status
00 00	Signature
Data Record 1: Volume Flow	
05	DIF (32 bit Real)
3E	VIF (Volume flow in m ³ /h)
XX XX XX XX	Act. measuring value
Data Record 2: Temperature	
05	DIF (32 bit Real)
5B	VIF (Temperature in °C)
XX XX XX XX	Act. measuring value
Data Record 3: Mass Flow	
05	DIF (32 bit Real)
53	VIF (Mass flow in kg/h)
XX XX XX XX	Act. measuring value
Data Record 4: Consumption Meter Reading	
05	DIF (32 bit Real)
16	VIF (Volume in m ³)
XX XX XX XX	Act. consumption value
Data Record 5: Flow Velocity	
05	DIF (32 bit Real)
7F	VIF (manufacturer specific in m/s)
XX XX XX XX	Act. measuring value
Data Record 6: Volume Flow	
04	DIF (32 bit Integer)
3B	VIF (Volume flow in 10 ⁻³ m ³ /h)
XX XX XX XX	Act. measuring value
Data Record 7: Temperature	
04	DIF (32 bit Integer)
59	VIF (Temperature in 10 ⁻² °C)
XX XX XX XX	Act. measuring value
Data Record 8: Mass Flow	
04	DIF (32 bit Integer)
51	VIF (Mass flow in 10 ⁻² kg/h)
XX XX XX XX	Act. measuring value
Data Record 9: Consumption Meter Reading	
07	DIF (64 bit Integer)
13	VIF (Volume flow in 10 ⁻³ m ³)
XX XX XX XX XX XX XX XX	Act. consumption value
Data Record 10: Flow Velocity	
04	DIF (32 bit Integer)
7F	VIF (manufacturer specific in 10 ⁻² m/s)
XX XX XX XX	Act. measuring value
End User Data	
XX	Checksum
16	End of the telegram

Tab. 5 Package structure of the measurement and consumption data

Secondary addressing

In addition to primary addressing, the EE741 flow sensor provides the option of secondary addressing. The fields of identification number, manufacturer, version and medium are used together as the secondary address. The exact sequence of the secondary addressing is described in detail in the M-Bus Standard: <https://m-bus.com/assets/downloads/MBDOC48.PDF>.

M-Bus Setup

	Factory settings	Adjustable values
Baud rate	2 400	600, 1 200, 2 400, 4 800, 9 600
Data bits	8	8
Parity	Even	None, odd, even
Stop bits	1	1 or 2
M-Bus address	240	0...254

Tab. 6 M-Bus protocol settings

i PLEASE NOTE

For several devices on the bus, the max. recommended baud rate is 9 600.

6.1.2. Modbus RTU Register Map

The measured values are stored as 32 bit floating point values (FLOAT32) and as 64 bit floating point values (DOUBLE64). Depending on the measurement unit selected, the measurements are saved in SI or US/GB units. The measurement unit can be changed using the configuration software.

For resetting the MIN/MAX values, 0 has to be written to to the corresponding write register.

For Modbus protocol setting please see Application Note AN0103 available at www.epluse.com/ee741.

FLOAT32

Parameter	Unit	Register number ¹⁾ [DEC]	Register address ²⁾ [HEX]
Read register: function code 0x03 / 0x04			
Temperature	°C	501	1F4
Temperature	°F	503	1F6
Standardized flow	m/s	507	1FA
Standardized flow	SFPM	509	1FC
Mass flow	kg/h	511	1FE
Mass flow	kg/min	513	200
Standardized volume flow	m ³ /h	517	204
Standardized volume flow	m ³ /min	519	206
Standardized volume flow	l/min	521	208
Standardized volume flow	l/s	523	20A
Standardized volume flow	SCFM	525	20C

DOUBLE64

Consumption meter reading	m ³	529	210
Consumption meter reading	ft ³	533	214

FLOAT32

Consumption meter reading	m ³	537	218
Consumption meter reading	ft ³	538	21A
MIN value temperature	°C	1001	3E8
MIN value temperature	°F	1003	3EA
MIN value standardized flow	m/s	1007	3EE
MIN value standardized flow	SFPM	1009	3F0
MIN value mass flow	kg/h	1011	3F2
MIN value mass flow	kg/min	1013	3F4
MIN value standardized volume flow	m ³ /h	1017	3F8
MIN value standardized volume flow	m ³ /min	1019	3FA
MIN value standardized volume flow	l/min	1021	3FC
MIN value standardized volume flow	l/s	1023	3FE
MIN value standardized volume flow	SCFM	1025	400
MAX value temperature	°C	1501	5DC
MAX value temperature	°F	1503	5DE
MAX value standardized flow	m/s	1507	5E2
MAX value standardized flow	SFPM	1509	5E4
MAX value mass flow	kg/h	1511	5E6
MAX value mass flow	kg/min	1513	5E8
MAX value standardized volume flow	m ³ /h	1517	5EC
MAX value standardized volume flow	m ³ /min	1519	5EE
MAX value standardized volume flow	l/min	1521	5F0
MAX value standardized volume flow	l/s	1523	5F2
MAX value standardized volume flow	SCFM	1525	5F4

1) Register number (decimal) starts from 1.

2) Register address (hexadecimal) starts from 0.

Tab. 7 EE741 measured data registers

Write registers for (re)setting values**INT16**

Parameter	Register number ¹⁾ [DEC]	Register address ²⁾ [HEX]
Write register: function code 0x06		
Reset MIN value temperature	1	0
Reset MIN value standardized flow	2	1
Reset MIN value mass flow	3	2
Reset MIN value standardized volume flow	4	3
Reset MAX value temperature	5	4
Reset MAX value standardized flow	6	5
Reset MAX value mass flow	7	6
Reset MAX value standardized volume flow	8	7
Reset consumption meter	9	8

FLOAT32

Write register: function code 0x10		
Process pressure in mbar	18	11

1) Register number (decimal) starts from 1.

2) Register address (hexadecimal) starts from 0.

Tab. 8 EE741 registers for device setup

Modbus RTU Setup

	Factory settings	Selectable values
Baud rate	9 600	9 600, 19 200, 38 400
Data bits	8	8
Parity	Even	None, Odd, Even
Stop bits	1	1 or 2
Modbus address	240	1...247

Tab. 9 Modbus RTU protocol settings

i PLEASE NOTE

The recommended baud rate for several devices in the Modbus RTU network is 9 600.

Device address, baud rate, parity and stop bits can be set via:

- EE-PCS Product Configuration Software and the USB configuration adapter HA011066. Please also refer to chapter 6.2 USB Configuration Interface.
The EE-PCS10 can be downloaded free of charge from www.epluse.com/configurator.
- Modbus protocol in the register 1 (0x00) and 2 (0x01).
See Application Note Modbus AN0103 (available at www.epluse.com/ee741).

The serial number as ASCII-code is located in read-only registers 1 - 8 (0x00 - 0x07).

The firmware version is located in register 9 (0x08) (bit 15...8 = major release; bit 7...0 = minor release). The sensor name as ASCII-code is located in read-only registers 10 - 17 (0x09 - 0x11).

NOTICE

When reading information that spans multiple registers, it is always necessary to read all registers, even if the desired information requires less.

NOTICE

For obtaining the correct floating point values, both registers have to be read within the same reading cycle. The measured value can change between two Modbus requests, exponent and mantissa may get inconsistent then.

i INFO

The Modbus function codes mentioned throughout this document shall be used as described in the MODBUS APPLICATION PROTOCOL SPECIFICATION V1.1b3, chapter 6:

www.modbus.org/docs/Modbus_Application_Protocol_V1_1b3.pdf

Communication settings (INT16)

Parameter	Register number ¹⁾ [Dec]	Register address ²⁾ [Hex]	Size ³⁾
Write register: function code 0x06			
Modbus address ⁴⁾	1	00	1
Modbus protocol settings ⁴⁾	2	01	1

Device information (INT16)

Parameter	Register number ¹⁾ [Dec]	Register address ²⁾ [Hex]	Size ³⁾
Read register: function code 0x03 / 0x04			
Serial number (as ASCII)	1	00	8
Firmware version	9	08	1
Sensor name	10	09	8

1) Register number (decimal) starts from 1.

2) Register address (hexadecimal) starts from 0.

3) Number of registers

4) For Modbus address and protocol settings see Application Note Modbus AN0103 (available at www.epluse.com/ee741).

i PLEASE NOTE**Bus termination resistor:**

Bus termination is required for the last flow sensor in a Modbus RTU network. The 120 Ω termination resistor is located behind the blind of the USB port and can be switched on and off (see Fig. 17).

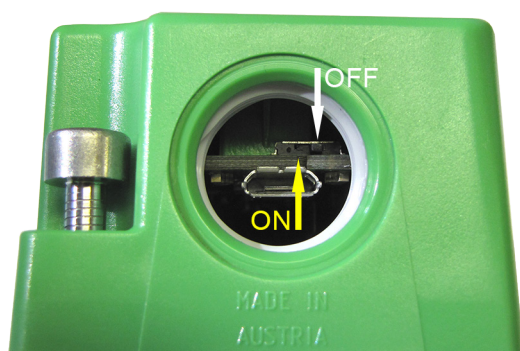

Fig. 17 Bus termination resistor

6.1.3. IO-Link

Communication specification	
Manufacturer ID	0563 _{hex} / 1379 _{dec}
Device IDs	EE741 DN15 to DN25 : 0x074111 475409 d EE741 DN32 to DN50 : 0x074112 475409 d
Bitrate	COM2 (38.4 kBaud)
Minimum cycle time	6.0 ms
SIO mode supported	no
Process data input length	12 bytes
IO-Link Revision	1.1
Required masterport class	A

Structure of process data input

The Process Data Input (the measured data of EE741) is configurable and structured in the following order:

Bit no.	95	64	63	32	31	0
Process data input	Measurand 1		Measurand 2		Measurand 3	
Measurand index, factory default acc. to Tab. 11	80 Mass flow m' [kg/h]		83 Standardized volume flow V'n [m ³ /h]		1 Temperature T [°C]	

Tab. 10 Scheme of process data input

Per factory default, the measurands' data type is FLOAT32 (more exactly, 32 bit single precision float). The parameters may freely be selected via IO-Link device parameter, the most usual are pre-selected per default. See Tab. 11 for the supported measurands.

Alternatively, the measured data may be represented as INT32 within the above scheme, the values are scaled with a factor 1 000 in this case.

i PLEASE NOTE

Please note that the data type selection (FLOAT32 or INT32) applies to the entire 12 byte process data input, i.e., all 3 measureands will have the same data type at the same time.

Measurand description	Formula Sign	Unit	Measurand Index
Temperature	T	°C	1
		°F	2
		K	4
Standardized flow	vn	m/s	22
		ft/min	23
Mass flow	m'	kg/h	80
		kg/min	81
		kg/s	82
Standardized volume flow	V'n	m ³ /h	83
		m ³ /min	84
		SLPM	85
		l/s	86
		SCFM	87
Consumption	Qn	m ³	91
		ft ³	93

Tab. 11 Indices of supported measurands

6.2 USB Configuration Interface

The micro USB port is located behind a blind cover (Fig. 18 and Fig. 19)



Fig. 18 Remove the blind cover



Fig. 19 Plug in the USB cable

i PLEASE NOTE

For setup and configuration of the EE741 via USB interface it is necessary to install the EE-PCS Product Configuration Software on a personal computer.

EE-PCS is available for free download at www.epluse.com/ee741. When an adjustment is performed using the EE-PCS, a suitable air velocity / temperature reference has to be used.

7 Display

The optional LC display shows the actual measured values and the overall consumption. The complete EE741 setup and configuration can be performed with the control keys and intuitive, self explanatory menu guidance.

i PLEASE NOTE

If the settings are changed during operation, it may affect the function of the system. Make sure that this does not cause any malfunctions in the system.

The display orientation can be changed in 90° steps via the settings menu to match the mounting position of EE741 (Fig. 20 and Fig. 21).



Fig. 20 Horizontal display



Fig. 21 Vertical display

7.1 Measured Value Display

Upon power on the display is in measuring mode and shows the measured values. Six measurands and a status page can be selected (Fig. 22 and Fig. 23).

Abbreviations for measurands:

Formula sign	Measurand
T	Temperature
V'n	Standardized volume flow
m'	Mass flow
Qn	Consumption
vn	Standardized flow

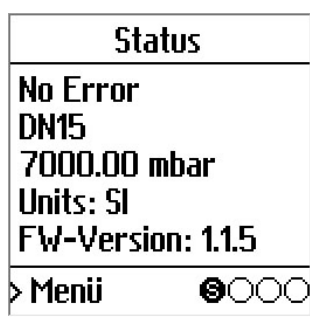

Fig. 22 Status display

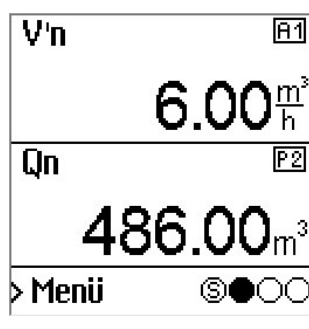

Fig. 23 Measured value display

Explanation of the symbols:

Symbol	Description
	Output 1 set to analogue output
	Output 2 set to pulse output/consumption
	Output 1 set to switching output; status OFF
	Output 1 set to switching output; status ON
	Output 2 set to switching output; status OFF
	Output 2 set to switching output; status ON

7.2 Display Menu

The display menu can be navigated and settings made using the four control keys allow for easy navigation and intuitive device setup.

Symbol	Description
	SELECT/SAVE
	BACK/CANCEL
	UP/increase value
	DOWN/decrease value

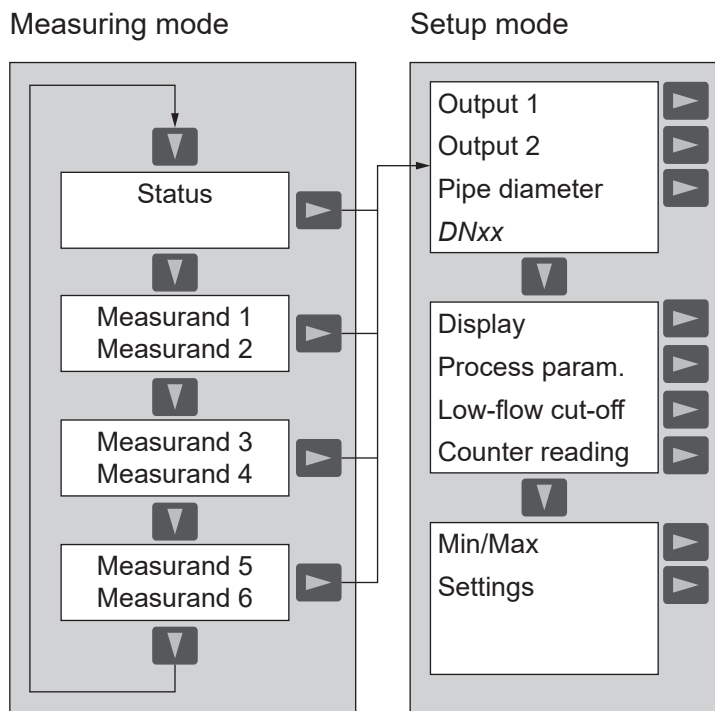

Fig. 24 Display - menu navigation

Setup Mode	Description
Output 1	Configuration for output 1: Analogue or switch output, measurand, scale and switch setup.
Output 2	Configuration for output 2: Switch or pulse output, measurand, switch setup.
Pipe diameter	Set the pipe diameter (see chapter 3.1.1 Changing the Pipe Diameter).
Display	Set the measuring mode and the display orientation.
Process parameter	Set the operating pressure and the standard conditions (see chapter 3.2.1 General).
Low-flow cut-off	Set the cut-off threshold for leak flow volume suppression (see chapter 3.2.1 General).
Counter reading	Display or reset the consumption meter.
Min / Max	Display or delete the min / max memory.
Settings	Language (English / German) Averaging of analogue output signal. Number of samples selectable between 1 and 50. The sampling interval is 0.1 s. E.g. <10 response time t_{90} <2 s 50 response time t_{90} 5 s

Fig. 25 Display - menu items

8 Maintenance and Service

8.1 Error Messages

Error messages are available at the status LEDs and on the status page of the optional display.

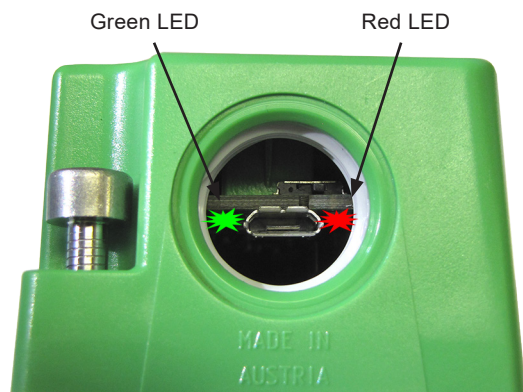

Fig. 26 Status LED - error message

LED States		Description	Recommended Action	
Green	Red			
Flashes	Off	No error		
Flashes	On	EEPROM faulty Cause: The consumption meter status and the MIN / MAX values are no longer available.	Consequence: All current measured values are shown on the display. The analogue, switch and pulse outputs operate normally.	Return the unit to E+E for service
		Display error Cause: The display or the communication with the display is faulty.	Consequence: Analogue, switch and pulse outputs operate normally	Return the unit to E+E for service
Flashes	Flashes	Sensor fault Cause: The sensing head is faulty.	Consequence: All measurands on the display are frozen at the lowest possible value, e.g. -20 °C (-4 °F) or 0 m ³ /h. The analogue output is frozen at 21 mA (NAMUR NE43).	Return the unit to E+E for service

Tab. 12 Explanation of the status led indicator

8.2 General Recommendations

It is recommended to calibrate the EE741 flow sensor on a yearly base.

For use with polluted media, the sensing head should be cleaned periodically.

8.3 Removal of the Sensing Unit from the Gauge Mounting Block

WARNING

Non-compliance with the product documentation may cause safety risk for people and the entire measurement installation.

The pipeline must be depressurized before mounting or removing the sensing unit.

Ensure that the line is depressurized and release the mounting screws of the sensing unit (Fig. 27 and Fig. 28).



Fig. 27 Unscrew mounting screws



Fig. 28 Remove sensing unit

For operation without the flow sensor installed see chapter 4.4.1 Operating the Pipeline without Sensing Unit.

8.4 Cleaning the Sensing Head

Clean the head of the sensor probe by carefully swirling in warm water or isopropyl alcohol. It is recommended to use isopropyl alcohol if the pollution is grease or oil.

PLEASE NOTE

Do not use an abrasive cleaning agent, an organic solvent containing halogen or acetone.

PLEASE NOTE

Do not touch the sensor by fingers or solid objects like screwdrivers or brushes.

Let the device dry in ambient air.

8.5 Repairs

Repairs are to be carried out by the manufacturer only. The attempt of unauthorized repair excludes any warranty claims.

9 Accessories

For further information see datasheet [Accessories](#).

Description	Code
Inlet and outlet path BSP thread, stainless steel for gauge mounting block	
DN15 (1/2")	HA070215
DN20 (3/4")	HA070220
DN25 (1")	HA070225
DN32 (1-1/4")	HA070232
DN40 (1-1/2")	HA070240
DN50 (2")	HA070250
M12x1 cable connector, 4-pole socket (plastic) for self assembly	HA010707
M12x1 cable connector, 5-pole socket (metal) for self assembly	HA010708
Connection cable, M12x1, 5-pole socket - free ends, shielded, PUR	
1.5 m (4.9 ft)	HA010819
5 m (16.4 ft)	HA010820
10 m (32.8 ft)	HA010821
Connection cable, M12x1 5-pole socket - plug, shielded, PUR	
2 m (6.6 ft)	HA010816
5 m (16.4 ft)	HA010817
10 m (32.8 ft)	HA010818
Connection Cable M12x1 4-pole socket, angled 90°	2 m (6.6 ft) HA010824
Sealing plugs for the gauge mounting block (for operating the pipeline without the sensing unit)	HA070204
Gasket set for gauge mounting block with flanges	
DN32 (1-1/4")	HA074532
DN40 (1-1/2")	HA074540
DN50 (2")	HA074550

10 Technical Data

Measurands

Volume Flow (V'n)

Standard conditions	Factory setting according to DIN 1343 pn = 1 013.25 mbar (14.7 psi); Tn = 0 °C (32 °F), freely configurable via EE-PCS																		
Measuring range ¹⁾ in air at standard conditions	<table border="0"> <tr> <td>DN15 (1/2")</td> <td>0.2...76.3 m³/h</td> <td>(0.12...44.88 SCFM)</td> </tr> <tr> <td>DN20 (3/4")</td> <td>0.4...135.7 m³/h</td> <td>(0.24...79.77 SCFM)</td> </tr> <tr> <td>DN25 (1")</td> <td>0.6...212 m³/h</td> <td>(0.36...124.71 SCFM)</td> </tr> <tr> <td>DN32 (1-1/4")</td> <td>0.9...347.4 m³/h</td> <td>(0.52...202.06 SCFM)</td> </tr> <tr> <td>DN40 (1-1/2")</td> <td>1.4...542.8 m³/h</td> <td>(0.81...315.71 SCFM)</td> </tr> <tr> <td>DN50 (2")</td> <td>2.2...848.2 m³/h</td> <td>(1.22...493.35 SCFM)</td> </tr> </table>	DN15 (1/2")	0.2...76.3 m ³ /h	(0.12...44.88 SCFM)	DN20 (3/4")	0.4...135.7 m ³ /h	(0.24...79.77 SCFM)	DN25 (1")	0.6...212 m ³ /h	(0.36...124.71 SCFM)	DN32 (1-1/4")	0.9...347.4 m ³ /h	(0.52...202.06 SCFM)	DN40 (1-1/2")	1.4...542.8 m ³ /h	(0.81...315.71 SCFM)	DN50 (2")	2.2...848.2 m ³ /h	(1.22...493.35 SCFM)
DN15 (1/2")	0.2...76.3 m ³ /h	(0.12...44.88 SCFM)																	
DN20 (3/4")	0.4...135.7 m ³ /h	(0.24...79.77 SCFM)																	
DN25 (1")	0.6...212 m ³ /h	(0.36...124.71 SCFM)																	
DN32 (1-1/4")	0.9...347.4 m ³ /h	(0.52...202.06 SCFM)																	
DN40 (1-1/2")	1.4...542.8 m ³ /h	(0.81...315.71 SCFM)																	
DN50 (2")	2.2...848.2 m ³ /h	(1.22...493.35 SCFM)																	
Accuracy ²⁾ in air @ 7 bar (102 psi) (abs) and 23 °C (73 °F)	±(3 % of measured value + 0.3 % of full scale)																		
Temperature dependency	±(0.25 % of measured value / °C deviating from 23 °C (73 °F))																		
Pressure dependency	Compensation by entering the system pressure using EE-PCS ³⁾																		
Response time t ₉₀	<2 s																		
Sampling interval	0.1 s																		

1) For factory setting, see chapter 10.1 Factory Setting of Outputs for DN15 / DN20 / DN25 and chapter 10.2 Factory settings of the outputs DN32 / DN40 / DN50.

2) The tolerance specifications include the uncertainty of the factory calibration with a coverage factor k=2 (2 x standard deviation).

The tolerance was calculated in accordance with EA-4/02 following the GUM (Guide to the Expression of Uncertainty in Measurement).

3) The flow meter is factory adjusted at 7 bar (abs, 102 psi). Pressure compensation is valid for v = 10...120 m/s. Without entering the system pressure into the EE741, the pressure dependency is ±0.5 % of the measured value / bar deviating from 7 bar.

Temperature (T)

Measuring range	-20...+60 °C (-4...+140 °F)
Accuracy @ 24 V DC, 20 °C (68 °F)	±0.7 °C (±1.26 °F)

Outputs

Analogue

Analogue output (scalable)	0 - 20 mA / 4 - 20 mA	$R_L < 500 \Omega$	$R_L = \text{load resistance}$
Switching output	DC PNP, max. 100 mA, $V_{\text{drop}} < 2.5 \text{ V}$, 10 k Ω pull-down Configurable: N/C or N/O, hysteresis, window		
Pulse output	Totalizer (Consumption meter)		
Pulse length	0.02...2 s		



Digital

Digital interface	RS485 (EE741 = 1 unit load)
Protocol Factory settings Supported Baud rates ¹⁾ Measured data types	Modbus RTU 9 600 Baud, parity even, 1 stop bit, Modbus address 240 600, 1 200, 2 400, 4 800, 9 600, 19 200, 38 400 and 57 600 FLOAT32 and DOUBLE64
Protocol Factory settings Supported Baud rates ²⁾ Measured data types	M-Bus 2 400 Baud, parity even, 1 stop bit, M-Bus address 240 600, 1 200, 2 400, 4 800 and 9 600 FLOAT32 or INT32
Protocol Interface specification Measured data types Service interface	IO-Link IO-Link v1.1, IO-Link device, COM2 (38.4 kBaud) FLOAT32 or INT32 USB

1) For further details on the communication setting: See chapter 6.1.2 Modbus RTU Register Map and Modbus Application Note at www.epluse.com/ee741.

2) For further details on the communication setting: See chapter.6.1.1 M-Bus (Meter-Bus).

General

Power supply class III  USA & Canada: Class 2 supply necessary	18 - 30 V DC
Current consumption, max. with display without display	$\leq 120 \text{ mA}$ ($P_{\text{max}} \leq 2.5 \text{ W}$) $\leq 60 \text{ mA}$ ($P_{\text{max}} \leq 1.6 \text{ W}$)
Electrical connection	M12x1 plug, 4 pole
Operating pressure, max.	16 bar (232 psi) / PN16
Humidity working range	0...100 %RH, non-condensing
Ambient temperature range with display without display	0...+50 °C -20...+60 °C
Medium and storage temperature range	-20...+60 °C
Medium	Compressed air or non-corrosive gases
Material Enclosure sensing unit Sensing head / sensor element Gauge mounting block Gauge mounting block with flanges	Polycarbonate (PC) Stainless steel 1.4404 / glass Aluminium anodised or stainless steel 1.4404 Entire media contacting surface in stainless steel 1.4404
Enclosure protection rating	IP65
Electromagnetic compatibility	EN 61326-1 EN 61326-2-3 Industrial environment FCC Part15 Class A ICES-003 Class A
Conformity	 

10.1 Factory Setting of Outputs for DN15 / DN20 / DN25

	Pipe Ø	Analogue output		Switch output hysteresis mode		Minimum flow shutdown	
		from	to	SP	HY	SP	HY
Standardized volume flow [m ³ /h]	DN15	0	75	50	5	0.15	0.07
	DN20	0	130	90	9	0.25	0.12
	DN25	0	200	150	15	0.35	0.17
Standardized volume flow [m ³ /min]	DN15	0	1.25	0.83	0.08		
	DN20	0	2.15	1.5	0.15		
	DN25	0	3.3	2.5	0.25		
Standardized volume flow [l/min]	DN15	0	1250	833	83		
	DN20	0	2150	1500	150		
	DN25	0	3300	2500	250		
Standardized volume flow [l/s]	DN15	0	20	14	1.4		
	DN20	0	35	25	2.5		
	DN25	0	55	40	4		
Standardized volume flow [SCFM]	DN15	0	44	30	3	0.15	0.07
	DN20	0	76	53	5.3	0.25	0.12
	DN25	0	117	88	8.8	0.35	0.17
Mass flow [kg/h]	DN15	0	97	65	6.5		
	DN20	0	165	115	11.5		
	DN25	0	255	195	19.5		
Mass flow [kg/min]	DN15	0	1.6	1	0.1		
	DN20	0	2.8	2	0.2		
	DN25	0	4.3	3.2	0.32		
Standardized flow [m/s]	DN15	0	120	80	8		
	DN20	0	120	80	8		
	DN25	0	120	80	8		
Standardized flow [SCFM]	DN15	0	23600	15000	1500		
	DN20	0	23600	15000	1500		
	DN25	0	23600	15000	1500		
Temperature [°C]	DN15	-20	60	24	0.5		
	DN20	-20	60	24	0.5		
	DN25	-20	60	24	0.5		
Temperature [°F]	DN15	-4	140	75	1		
	DN20	-4	140	75	1		
	DN25	-4	140	75	1		

Pulse output:

Pulse duration: 0.1 s

Pulse value: 1 m³

Measured value averaging: 10

10.2 Factory settings of the outputs DN32 / DN40 / DN50

	Pipe Ø	Analogue output		Switch output hysteresis mode		Minimum flow shutdown	
		from	to	SP	HY	SP	HY
Standardized volume flow [m ³ /h]	DN32	0	300	200	20	0.55	0.25
	DN40	0	500	350	35	0.9	0.45
	DN50	0	800	600	60	1.4	0.7
Standardized volume flow [m ³ /min]	DN32	0	5	3.3	0.3		
	DN40	0	8.3	5.8	0.58		
	DN50	0	13.3	10	1		
Standardized volume flow [l/min]	DN32	0	5000	3300	330		
	DN40	0	8300	5800	580		
	DN50	0	13300	10000	1000		
Standardized volume flow [l/s]	DN32	0	83	56	5.6		
	DN40	0	139	97	9.7		
	DN50	0	222	167	16.7		
Standardized volume flow [SCFM]	DN32	0	176	117	11.7	0.55	0.25
	DN40	0	294	200	20	0.9	0.45
	DN50	0	470	350	35	1.4	0.7
Mass flow [kg/h]	DN32	0	390	260	26		
	DN40	0	650	450	45		
	DN50	0	1000	770	77		
Mass flow [kg/min]	DN32	0	6.5	4.3	0.43		
	DN40	0	10.8	7.5	0.75		
	DN50	0	17.2	13	1.3		
Standardized flow [m/s]	DN32	0	120	80	8		
	DN40	0	120	80	8		
	DN50	0	120	80	8		
Standardized flow [SCFM]	DN32	0	23600	15000	1500		
	DN40	0	23600	15000	1500		
	DN50	0	23600	15000	1500		
Temperature [°C]	DN32	-20	60	24	0.5		
	DN40	-20	60	24	0.5		
	DN50	-20	60	24	0.5		
Temperature [°F]	DN32	-4	140	75	1		
	DN40	-4	140	75	1		
	DN50	-4	140	75	1		

10.3 Works Certificate



—
your partner
in sensor
technology.

Werksbescheinigung nach DIN EN 10204-2.1



Works certificate according to DIN EN 10204-2.1

Zertifikat Nr. / Certificate No: **A032402x09**

Gegenstand / Object: **EE741-xxxx**
Durchflusssensor
Flow Sensor

Hiermit bestätigen wir, dass die angeführten E+E Erzeugnisse unter Verwendung einwandfreier Werkstoffe nach dem Stand der Technik gefertigt wurden. Produktion, Kalibrierung und Qualitätsprüfung werden im Rahmen der E+E Qualitätssicherungsmaßnahmen überwacht.

We herewith certify that above listed E+E products are manufactured with state of the art materials and components, in compliance with the latest technical standards. Manufacturing, calibration and quality tests are performed according to the E+E Quality Assurance System.

Werkstoffe / Materials

Messumformer / Transmitter

Gehäuse / enclosure	Polycarbonate UL94-V0
Dichtung / seal	EPDM
Stecker / connector	Messing vernickelt / brass nickel plated
Grundplatte / mounting plate	Aluminium / aluminum

Messfühler / Sensing Probe

Sensorkopf / sensing head	Edelstahl 1.4404 / stainless steel AISI 316L
O-Ring / o-Ring	FKM
Strömungssensor Element / Flow sensor element	Glas, polyimide coating

Messblock / Gauge Mounting Block

HA0790xx, HA1790xx	Aluminium eloxiert / aluminum anodized
HA0780xx, HA1780xx, HA0810xx, HA1810xx	Edelstahl 1.4404 / stainless steel AISI 316L
Dichtstopfen / sealing plug	Edelstahl 1.4405 mit TUFLOK Beschichtung / stainless steel AISI 303 with TUFLOK coating

Flansch - Messstrecke / Gauge Mounting Block with Flanges

HA0745xx	Edelstahl 1.4404 / stainless steel AISI 316L
	Aluminium AlMg4,5Mn / aluminum AlMg4.5Mn
	Stahl verzinkt / galvanized steel
Dichtstopfen / sealing plug	Edelstahl 1.4405 mit TUFLOK Beschichtung / stainless steel

Es wird bestätigt, dass das gelieferte Produkt der Bestellung entspricht.

This is to certify that the delivered product complies with the order.

Datum / Date: 09.02.2024

Geprüft / Supervisor

11 Conformity

11.1 Declarations of Conformity

E+E Elektronik Ges.m.b.H. hereby declares that the product complies with the respective regulations listed below:



European directives and standards.

and



UK statutory instruments and designated standards.

Please refer to the product page at www.epluse.com/ee741 for the Declarations of Conformity.

11.2 FCC Part 15 Compliance Statement

This equipment has been tested and found to comply with the limits for a Class A digital device, pursuant to part 15 of the FCC Rules. These limits are designed to provide reasonable protection against harmful interference when the equipment is operated in a commercial environment. This equipment generates, uses, and can radiate radio frequency energy and, if not installed and used in accordance with the instruction manual, may cause harmful interference to radio communications. Operation of this equipment in a residential area is likely to cause harmful interference in which case the user will be required to correct the interference at his own expense.

11.3 ICES-003 Compliance Statement

This Class A digital apparatus complies with Canadian ICES-003.

Cet appareil numérique de la classe A est conforme à la norme NMB-003 du Canada.

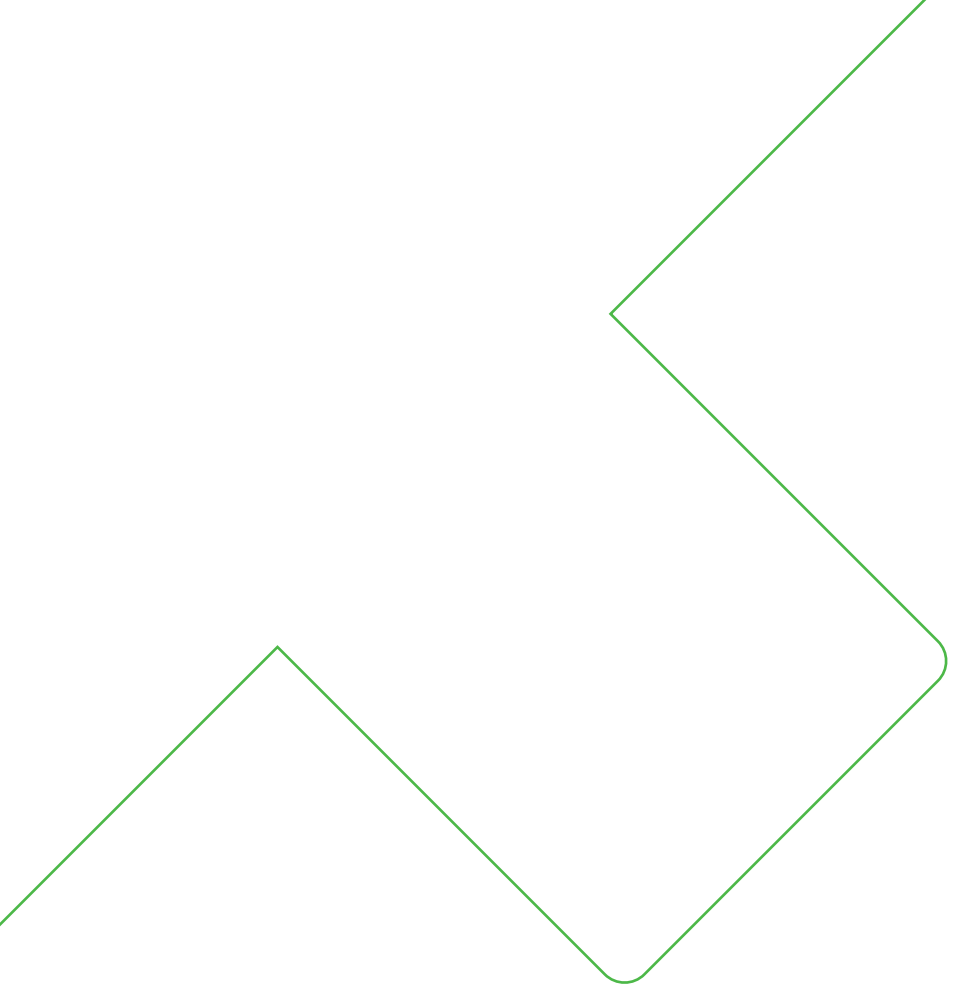

Company Headquarters &
Production Site

E+E Elektronik Ges.m.b.H.
Langwiesen 7
4209 Engerwitzdorf | Austria
T +43 7235 605-0
F +43 7235 605-8
info@epluse.com
www.epluse.com

Subsidiaries

E+E Sensor Technology (Shanghai) Co., Ltd.
T +86 21 6117 6129
info@epluse.cn

E+E Elektronik France SARL
T +33 4 74 72 35 82
info.fr@epluse.com

E+E Elektronik Deutschland GmbH
T +49 6171 69411-0
info.de@epluse.com

E+E Elektronik India Private Limited
T +91 990 440 5400
info.in@epluse.com

E+E Elektronik Italia S.R.L.
T +39 02 2707 86 36
info.it@epluse.com

E+E Elektronik Korea Ltd.
T +82 31 732 6050
info.kr@epluse.com

E+E Elektronik Corporation
T +1 847 490 0520
info.us@epluse.com



—
your partner
in sensor
technology.