

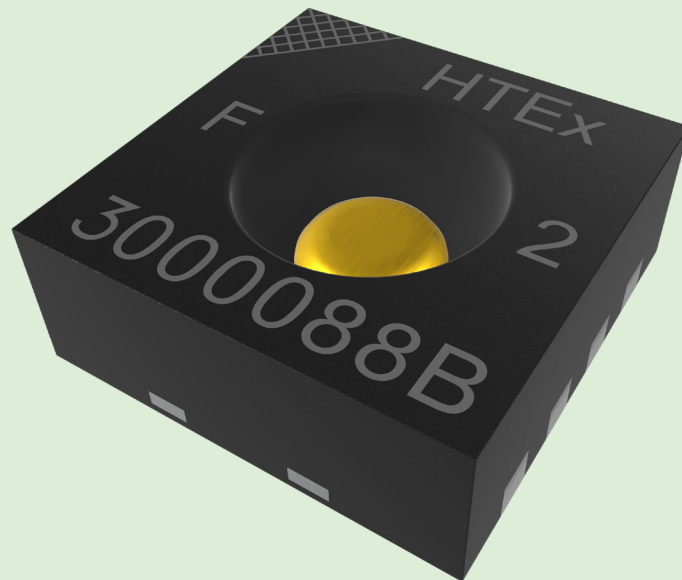

—  
your partner  
in sensor  
technology.

# **+ Datasheet HTE501**

**Digital Humidity and Temperature Sensor**



# HTE501

## Digital Humidity and Temperature Sensor

The next generation of digital RH/T sensor combines accuracy and reliability to meet the highest current and future requirements. The integrated constant current heater as well as the innovative and proven E+E proprietary coating ensures outstanding performance even in harsh environments.

In a DFN package with a footprint of only 2.5 x 2.5 mm, the HTE501 provides an exceptional accuracy of up to  $\pm 1.8$  %RH incl. hysteresis, paired with dew point calculation and a maximum of 8 devices on one I<sup>2</sup>C interface.

Furthermore, the sensor convinces with its application ranges from -40 to +135 °C and 0 to 100 %RH which make it the ideal measuring device for demanding tasks.

## Key Features

- Accuracy:
  - up to  $\pm 1.8$  %RH (incl. hysteresis)
  - up to  $\pm 0.2$  °C
- E+E proprietary coating
- Supply voltage 2.35 - 3.60 V
- 8-pin DFN package
- Constant current heater
- I<sup>2</sup>C interface with pin-selectable addresses
- Integrated I<sup>2</sup>C pull-up resistors
- I<sup>2</sup>C glitch suppression
- I<sup>2</sup>C interface with direct 16 bit integer output
- Dew point calculation
- Excellent repeatability

## Typical Applications

- Automotive industry
- Building automation
- Consumer electronics
- Home appliances
- Industrial automation
- Medical devices
- Smart home
- Wearable devices
- White goods

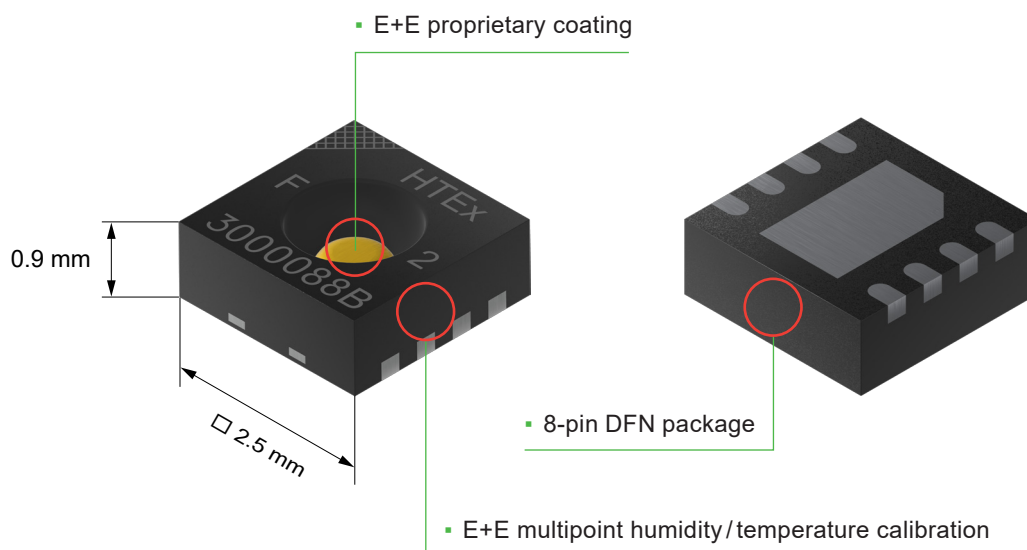

# CONTENTS

Introduction to the E+E Digital Humidity and Temperature Sensor.....	2
<b>1 Pin Configuration .....</b>	<b>6</b>
<b>2 Typical Application.....</b>	<b>6</b>
<b>3 Specification.....</b>	<b>7</b>
3.1 Relative Humidity Sensor.....	7
3.2 Temperature Sensor .....	7
3.3 Recommended Operating Conditions.....	8
<b>4 Electrical Characteristics.....</b>	<b>9</b>
4.1 Absolute Maximum Ratings.....	9
4.2 Electrical Specification .....	9
<b>5 Interface .....</b>	<b>11</b>
5.1 Pin Configuration, Assignment and Description.....	11
5.2 Supply Pins ( $V_{DD}$ , GND).....	11
5.3 I <sup>2</sup> C Communication .....	12
5.4 I <sup>2</sup> C Address Pins .....	12
5.5 $\overline{HI}$ Pin .....	13
<b>6 Sensor Communication .....</b>	<b>13</b>
6.1 Command Overview.....	13
6.2 Measured Data Format .....	14
6.3 Measurement Modes .....	14
6.4 Single Shot Measurement (0x2C1B, 0x241D).....	14
6.5 Periodic Measurement (0x201E).....	15
6.6 Fetch Periodic RH&T Measurement Results (0xE000).....	16
6.7 Fetch Td Measurement Results (0xE016).....	16
6.8 Break Command (0x3093) .....	17
6.9 Reset Commands (0x30A2, 0x06) .....	17
6.10 Status Register (0xF32D, 0xF352, 0x3041) .....	18
6.11 Read Identification (0x7029) .....	20
6.12 Constant Current Heater (0x306D, 0x3066).....	20
6.13 Change Sensor Settings (0x72A7).....	21
6.14 CRC Calculation .....	23
6.15 Package / Dimensions .....	23
6.16 Tape and Reel Packaging .....	24
6.17 Traceability .....	24
6.18 Ordering Information.....	25
6.19 Recommended Layout .....	25
<b>7 Quality.....</b>	<b>25</b>
<b>8 Additional Documentation .....</b>	<b>25</b>
<b>9 Revision History .....</b>	<b>26</b>

## LIST OF FIGURES

Figure 1: DFN8 pin configuration.....	6
Figure 2: Typical application schematic.....	6
Figure 3: Humidity measurement accuracy @ 25 °C (incl. hysteresis).....	7
Figure 4: Temperature sensor accuracy.....	8
Figure 5: Operating conditions.....	8
Figure 6: Measurement duration.....	11
Figure 7: Sensor behaviour at power-up.....	12
Figure 8: Single shot measurement.....	14
Figure 9: Periodic measurement.....	14
Figure 10: Start single shot measurement readout.....	15
Figure 11: Clock stretching during measurement.....	15
Figure 12: Poll for measuring values until ACK.....	15
Figure 13: Measured value readout.....	15
Figure 14: Periodic measurement commands.....	16
Figure 15: Fetch command.....	16
Figure 16: Fetch command.....	17
Figure 17: Break command.....	17
Figure 18: Soft reset.....	17
Figure 19: Reset through general call.....	18
Figure 20: Read out status register.....	18
Figure 21: Clear status register 1.....	18
Figure 22: Read Identification.....	20
Figure 23: Constant current heater commands.....	21
Figure 24: Memory access.....	21
Figure 25: Sensor settings example: HEATER OFF.....	22
Figure 26: Sensor settings example: set measurement interval (back) to 1 second.....	22
Figure 27: Package layout.....	23
Figure 28: Tape layout.....	24
Figure 29: Orientation on the tape.....	24
Figure 30: HTE <sub>x</sub> laser marking.....	24
Figure 31: Recommended land pattern and stencil aperture.....	25

## LIST OF TABLES

Table 1: List of HTE501 specific acronyms .....	5
Table 2: HTE501 pin assignment.....	6
Table 3: Relative humidity sensor.....	7
Table 4: Temperature sensor parameters .....	7
Table 5: HTE501 absolute maximum ratings .....	9
Table 6: General operation .....	9
Table 7: I <sup>2</sup> C communication pins SCL & SDA.....	10
Table 8: I/O pins .....	10
Table 9: General timing .....	10
Table 10: Measurement resolution .....	11
Table 11: HTE501 commands.....	13
Table 12: Single shot measurement with or without clock stretching .....	14
Table 13: Status register 1 .....	19
Table 14: Status register 2 .....	19
Table 15: Sensor settings registers .....	22
Table 16: CRC checksum calculation .....	23
Table 17: Package dimensions.....	23
Table 18: Applicable documentation .....	25
Table 19: Revision history .....	26

Acronym	Meaning
A	Ambient
B	Bus
CDM	Charged Device Model
ESD	Electrostatic Discharge
HBM	Human Body Model
HI	Heater Invalid
MEAS	Measurement, Measuring
PORI	Power On Reset, Idle Mode
PU	Pull-up
POR	Power On Reset
PORP	Power On Reset, Periodic Mode
PUPE	Pull-up external
PUPI	Pull-up internal
RH	Relative humidity
Td	Dew point temperature
T	Temperature

**Table 1:** List of HTE501 specific acronyms

# 1 Pin Configuration

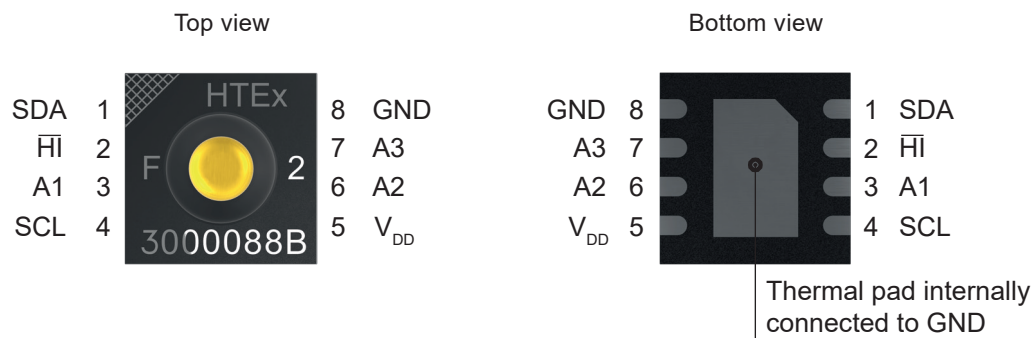

Figure 1: DFN8 pin configuration

Pin	Name	Pin Type	Description
1	SDA	I/O with pull-up	Serial data line for I <sup>2</sup> C communication
2	HI	Output open drain	Indicates heater status and measurement invalid <sup>1)</sup>
3	A1	Input high-Z	I <sup>2</sup> C device address pin, bit 1 of the 7 bit address; do not leave floating
4	SCL	I/O with pull-up	Serial clock line for I <sup>2</sup> C communication
5	V <sub>DD</sub>	Power	Positive supply pin
6	A2	Input high-Z	I <sup>2</sup> C device address pin, bit 2 of the 7 bit address; do not leave floating
7	A3	Input high-Z	I <sup>2</sup> C device address pin, bit 3 of the 7 bit address; do not leave floating
8	GND	Power	Ground (internally connected to thermal pad) <sup>2)</sup>

1) If unused see pin description (HI Pin).

2) Soldering of the thermal pad is optional. However, the soldering is recommended. Do not use the heat conduction pad on the PCB for heat dissipation but purely as a mounting surface, otherwise heating energy is lost.

Table 2: HTE501 pin assignment

# 2 Typical Application

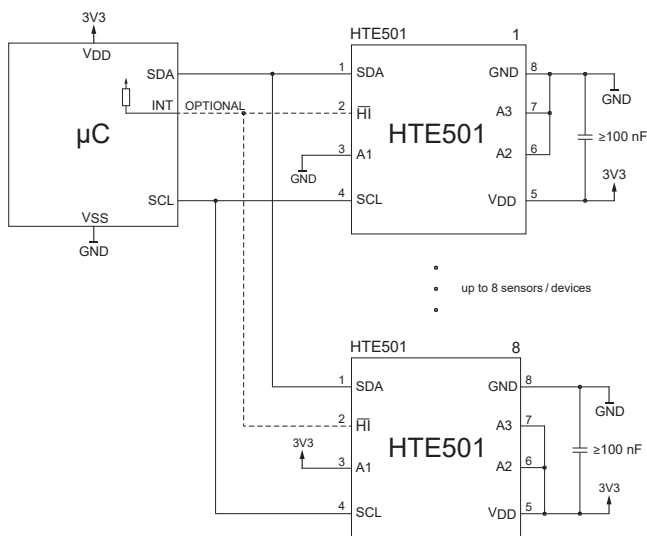

Figure 2: Typical application schematic

### 3 Specification

#### 3.1 Relative Humidity Sensor

PARAMETER	CONDITION(S)	MIN	TYP	MAX	UNITS
Operating range		0		100	%RH
Accuracy <sup>1) 2) 3)</sup>	Periodic mode, Td < 80 °C		±1.8	See Figure 3	%RH
Hysteresis <sup>2)</sup>			±0.9		%RH
Resolution <sup>4)</sup>	13 bit		0.02		%RH
Repeatability <sup>5)</sup>	13 bit		0.02		%RH
Response time <sup>6)</sup>	$\tau_{63}$		5		s
Long term drift <sup>7)</sup>			<0.5%		%RH/yr

Table 3: Relative humidity sensor

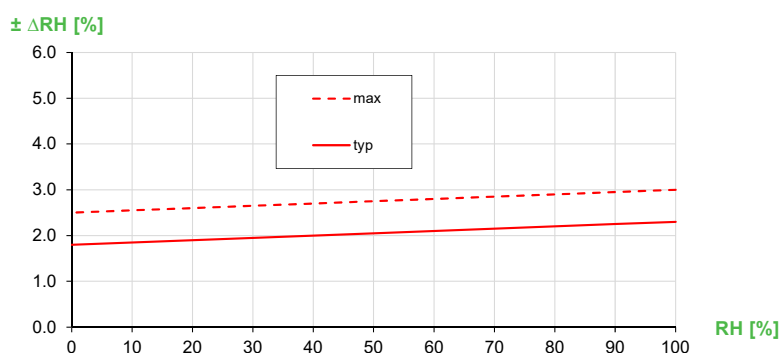

Figure 3: Humidity measurement accuracy @ 25 °C (incl. hysteresis)

#### 3.2 Temperature Sensor

PARAMETER	CONDITION	MIN	TYP	MAX	UNIT
Operating Range <sup>8)</sup>	Heater OFF	-40		135	°C
Accuracy			0.2	See Figure 4	°C
Resolution <sup>9)</sup>	13 bit		0.01		°C
Repeatability <sup>5)</sup>	13 bit		0.03		°C
Response time <sup>10)</sup>	$\tau_{63}$	2			s
Long Term Drift			<0.03		°C/yr

Table 4: Temperature sensor parameters

- 1) In the periodic mode the humidity hysteresis is included. See also chapter 3.3 Recommended Operating Conditions.
- 2) In the periodic mode the humidity accuracy is within the hysteresis. In the single shot measurement, the humidity hysteresis must be added to the given humidity accuracy to obtain the overall accuracy.
- 3) The detailed definition of “typ.” and “max.” is given in the document Sensor Specification Accuracy, available at [www.epluse.com/hte501](http://www.epluse.com/hte501).
- 4) Default resolution is 13 bit temperature / 13 bit humidity. Resolution is changeable with register value.
- 5) The stated “Noise/Repeatability” is 3 times the standard deviation (3σ) of multiple consecutive measurement values at constant environmental conditions.
- 6) Time for achieving 63 % of a step function, valid at 25°C and 1 m/s airflow.  
The actual response time in application strongly depends on the surrounding of the sensor in the final application (heat conductivity of sensor substrate, dead volume,...).
- 7) Value may be higher in environments with vaporized solvents, out-gassing tapes, adhesives, packaging materials, etc. For more details please refer to the HTE501 Handling Instructions.
- 8) With the “Heater ON” take care that the sensor temperature does not get higher than the maximum allowed temperature
- 9) Default resolution is 13 bit temperature / 13 bit humidity. Resolution is changeable with register value.
- 10) Time for achieving 63 % of a step function, valid at 25°C and 1m/s airflow.  
The actual response time in application strongly depends on the surrounding of the sensor in the final application (heat conductivity of sensor substrate, dead volume, ...).

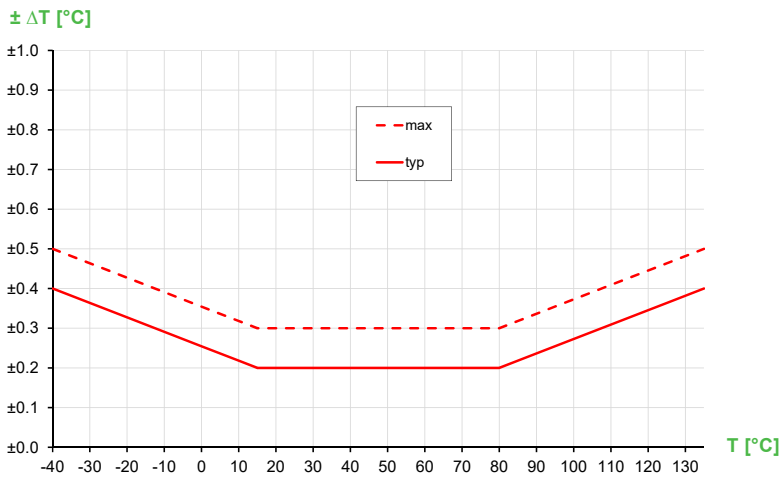

Figure 4: Temperature sensor accuracy

### 3.3 Recommended Operating Conditions

The sensor shows best performance when operated within the normal operating conditions (dark green area in Figure 5). This means 20...80 %RH, temperature >0 °C and dew point temperature <60 °C.

Exposure conditions outside this “Normal operating condition” for a long time, especially at high humidity >80 %RH may cause a temporary humidity gain error. If the sensor is brought back to normal operating conditions, the initial values will recover. Applications with high humidity at high temperatures will result in slower recovery. Reconditioning procedures can accelerate the recovery process.

Although the sensors would not fail beyond the normal operating condition limits, the specification is guaranteed within the “Normal operating condition” or within the “Extended operating conditions” (light green area) after a reconditioning procedure.

Prolonged exposure to extreme operating conditions (marked orange in Figure 5) may accelerate ageing.

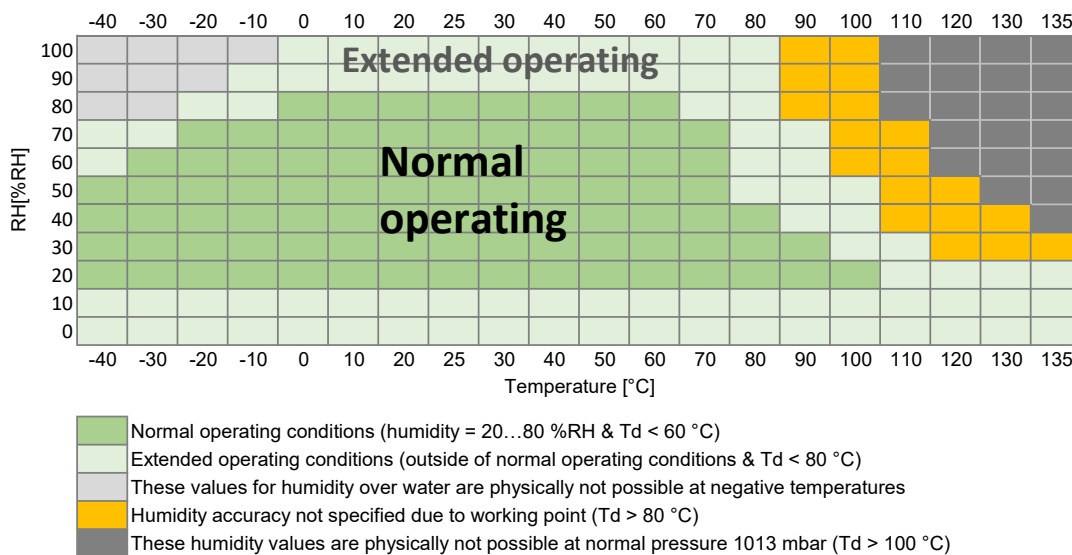

Figure 5: Operating conditions



## 4 Electrical Characteristics

### 4.1 Absolute Maximum Ratings

The absolute maximum ratings as given in Table 5 are stress ratings only and give additional information. Functional operation of the device at these conditions is not implied. Exposure to absolute maximum rating conditions for extended periods may affect the device reliability (e.g. hot carrier degradation, oxide breakdown).

PARAMETER	SYMBOL	MIN	MAX	UNIT
Power supply	$V_{DD}$	-0.3	3.6	V
Digital I/O pins	$V_{LOGIC}$	-0.3	5.0	V
Input current on any pin	$I_{IN}$	-50	50	mA
Storage temperature	$T_{STG}$	-55	150	°C
ESD HBM <sup>1)</sup>	$ESD_{HBM}$	-	4	kV
ESD CDM <sup>2)</sup>	$ESD_{CDM}$	-	750	V

1) Human Body Model according to AEC-Q100-002

2) Charged Device Model according to AEC-Q100-011

Table 5: HTE501 absolute maximum ratings

### 4.2 Electrical Specification

Typical values correspond to  $V_{DD} = 3.3\text{ V}$  and  $T_A = 25\text{ °C}$ .

Min. and max. values are valid in the full temperature range  $-40\text{ °C} \dots 135\text{ °C}$  and at declared  $V_{DD}$  levels, unless otherwise noted.

PARAMETER	SYMBOL	CONDITION / COMMENT	MIN	TYP	MAX	UNIT
Supply Voltage	$V_{DD}$		2.35	3.0	3.6	V
POR voltage periodic mode	$V_{PORP}$	Static power supply	2.10	2.20	2.35	V
POR voltage idle mode	$V_{PORI}$	Static power supply		1.8		V
Supply current	$I_{DD}$	Single mode (idle) <sup>1)</sup>		6		μA
		Periodic mode <sup>1)</sup>		80		μA
		Measuring T, RH, Calculation		900		μA
		Constant current heater, adjustable <sup>2)</sup>		5...80		mA
Thermal resistance	$R_{TH}$	Dependent on PCB layout and environmental conditions		150		K/W

1) Without I<sup>2</sup>C communication and when not measuring.

2) The chip temperature must not exceed 135°C with heater on. For example  $V_{DD} = 3.3\text{ V}$ , heater current = 80 mA →  $P_{HEAT} = 0.264\text{ W}$

→ Overtemperature ~40 °C ( $R_{TH} \sim 150\text{ K/W}$ ) → Ambient temperature < 95 °C → check the measured temperature while constant current heater is on.

Table 6: General operation

PARAMETER	SYMBOL	CONDITION / COMMENT	MIN	TYP	MAX	UNIT
Input voltage	V <sub>IL</sub>	Low level			0.3*V <sub>DD</sub>	V
	V <sub>IH</sub>	High level	0.7*V <sub>DD</sub>		V <sub>DD</sub>	V
Output voltage	V <sub>OL</sub>	Current into pin: I <sub>OL</sub> = 4.0 mA	0	0.25	0.40	V
	V <sub>OH</sub>	High level → open drain				
Internal pull-up resistor	R <sub>PUP1</sub>	V <sub>DD</sub> =3.60 V & pin voltage = 0.7*V <sub>DD</sub>		25		kΩ
		V <sub>DD</sub> =3.30 V & pin voltage = 0.7*V <sub>DD</sub>		27		kΩ
		V <sub>DD</sub> =3.00 V & pin voltage = 0.7*V <sub>DD</sub>		30		kΩ
		V <sub>DD</sub> =2.35 V & pin voltage = 0.7*V <sub>DD</sub>		34		kΩ
External pull-up resistor	R <sub>PUP2</sub>	At I <sup>2</sup> C lines, pull-up current ≤4.0 mA @ 3.3 V	0.725	4.7		kΩ
Capacitive bus load	C <sub>B</sub>	Standard			400	pF
		Fast mode			400	pF
		Fast mode plus			177	pF

Table 7: I<sup>2</sup>C communication pins SCL & SDA

PARAMETER	SYMBOL	CONDITION / COMMENT	MIN	TYP	MAX	UNIT
Input voltage	V <sub>IL</sub>	Low level			0.3*V <sub>DD</sub>	V
	V <sub>IH</sub>	High level, 5V tolerant input	0.7*V <sub>DD</sub>	V <sub>DD</sub>	5.0	V
Input leakage current	I <sub>VDD</sub>	Voltage @pin = 0...V <sub>DD</sub>	-10	0	+10	μA
	I <sub>ISV</sub>	Voltage @pin = V <sub>DD</sub> ...5 V		TBD		μA
Output resistance	R <sub>OH</sub>	Voltage @pin = V <sub>DD</sub> -0.4 V		116		Ω
	R <sub>OL</sub>	Voltage @pin = 0.4 V		100		Ω

Table 8: I/O pins

PARAMETER	SYMBOL	CONDITION / COMMENT	TYP	UNIT
Power-up time	t <sub>PWRU</sub>	After V <sub>DD</sub> > V <sub>PORP</sub> , exclude measurement at power-up	1.1	ms
Reset time	t <sub>RESET</sub>	Any reset except power-up	0.9	ms
T Measurement	t <sub>T</sub>	8 bit resolution	0.3	ms
		9 bit resolution	0.6	ms
		10 bit resolution	1.2	ms
		11 bit resolution	2.3	ms
		12 bit resolution	4.5	ms
		13 bit resolution	8.9	ms
		14 bit resolution	17.8	ms
RH Measurement	t <sub>RH</sub>	8 bit resolution	0.1	ms
		9 bit resolution	0.3	ms
		10 bit resolution	0.5	ms
		11 bit resolution	1.0	ms
		12 bit resolution	2.0	ms
		13 bit resolution	4.1	ms
		14 bit resolution	8.1	ms
Measurement calculation	t <sub>CALC</sub>	After every measurement	1.2	ms

Table 9: General timing

Subsequently, the typical time from V<sub>DD</sub> > V<sub>PORP</sub> to measurement ready in the standard configuration is:

$$t_{RDY} = t_{PWRU} + t_{MEAS} = t_{PWRU} + t_T + t_{RH} + t_{CALC} = 15.3 \text{ ms}$$

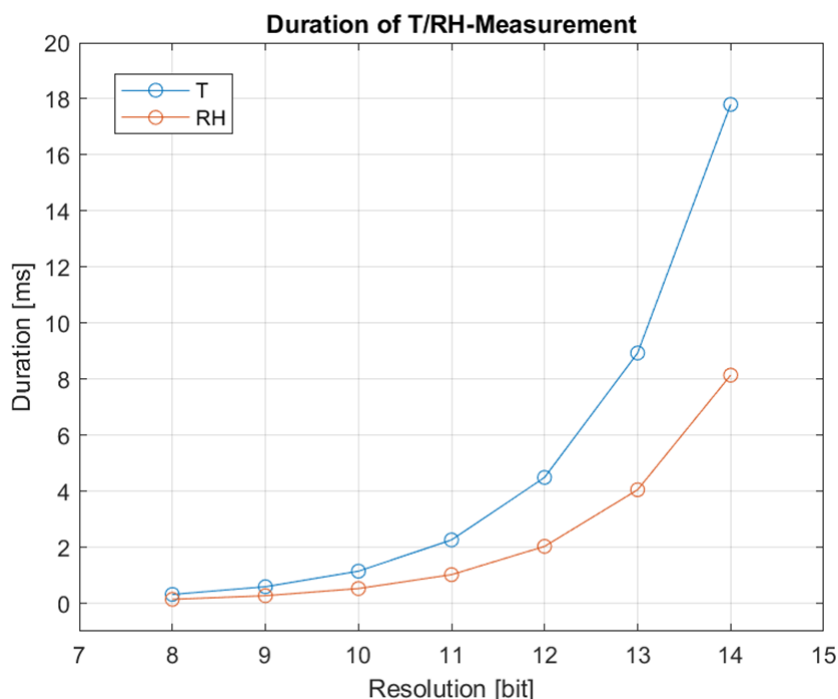

Figure 6: Measurement duration

bit	Temperature	Humidity
	Resolution [°C]	Resolution [%RH]
14	0.01	0.01
13	0.01	0.02
12	0.02	0.04
11	0.06	0.09
10	0.11	0.18
9	0.21	0.35
8	0.42	0.69

Table 10: Measurement resolution

## 5 Interface

### 5.1 Pin Configuration, Assignment and Description

Please refer to chapter 1.

### 5.2 Supply Pins ( $V_{DD}$ , GND)

The supply pins must be equipped with a bypass ceramic capacitor of at least 100 nF.

When using the constant current heater, a current change in the heater must not lead to a voltage drop below the minimum  $V_{DD}$  value (refer to Table 6). This means the bypass capacitor needs to be dimensioned sufficiently large so that the voltage controller is supplied adequately.

#### Sensor Power-up

As soon as  $V_{DD}$  exceeds the POR voltage  $V_{PORP}$ , the device gets initialized. After  $t_{PWRU}$ , the initialization procedure is completed and a single shot measurement is carried out automatically. After the measurement time ( $t_T+t_{RH}+t_{CALC}$ ) the measured values are available at the I<sup>2</sup>C interface. The  $\overline{HI}$  pin indicates the availability of a valid temperature and humidity measurement after power-up (see pin description).

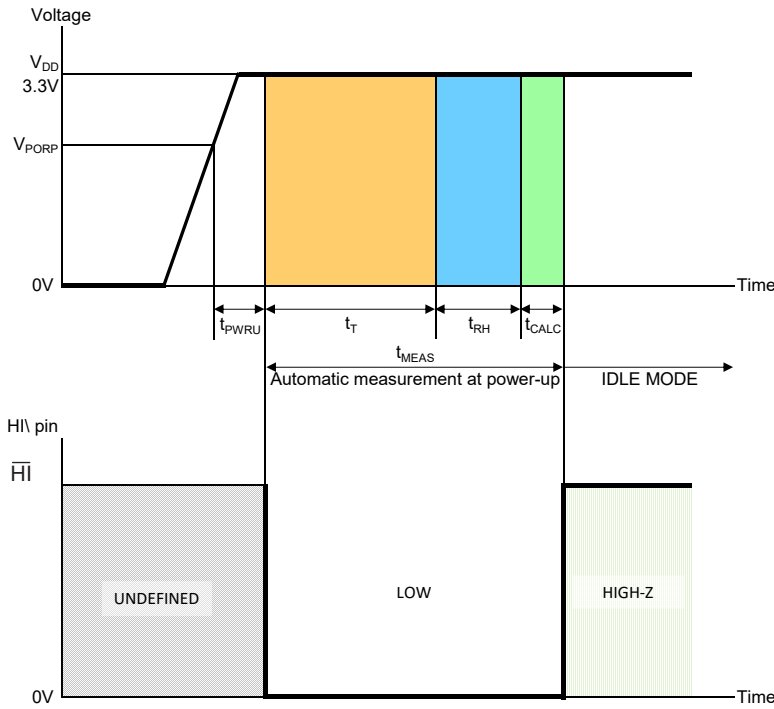

Figure 7: Sensor behaviour at power-up

### 5.3 I<sup>2</sup>C Communication

The I<sup>2</sup>C communication is based on the NXP UM10204 I<sup>2</sup>C bus specification and user manual<sup>1)</sup>. The HTE501 supports the modes “standard” (100 kHz), “fast mode”(400 kHz) and “fast mode plus” (1000 kHz).

The sensor works as SLAVE and needs to be queried by a MASTER.

Please consider self-heating due to a low R<sub>PU</sub> when the sensor has to sink the pull-up current. In this case, the residual voltage on the SCL or SDA pin briefly generates a power loss in the sensor.

Example: 4mA \* 0.4V = 1.6mW

### 5.4 I<sup>2</sup>C Address Pins

The sensor’s I<sup>2</sup>C base address is 0x40 (without R/W bit). Pins A1...A3 define the I<sup>2</sup>C base address.

Bit #	7	6	5	4	PIN 7	PIN 6	PIN 3	R/W	SLAVE Address (unshifted)	SLAVE Address (with W)	SLAVE Address (with R)
					A3	A2	A1				
	1	0	0	0	0	0	0	0/1	0x40	0x80	0x81
	1	0	0	0	0	0	1	0/1	0x41	0x82	0x83
	1	0	0	0	0	1	0	0/1	0x42	0x84	0x85
	1	0	0	0	0	1	1	0/1	0x43	0x86	0x87
	1	0	0	0	1	0	0	0/1	0x44	0x88	0x89
	1	0	0	0	1	0	1	0/1	0x45	0x8A	0x8B
	1	0	0	0	1	1	0	0/1	0x46	0x8C	0x8D
	1	0	0	0	1	1	1	0/1	0x47	0x8E	0x8F

## 5.5 $\overline{\text{HI}}$ Pin

The  $\overline{\text{HI}}$  pin means “Heater/Invalid” and it indicates that the measurement does not show the real environmental humidity and temperature conditions:

1. Internal heater on: the internal heater starts a self-heating, and therefore the temperature is higher and the humidity is lower than the surrounding environmental conditions actually are.
  - a. Heater ON (command 0x306D) → pin = LOW
  - b. Heater OFF (command 0x3066) → pin = high-Z
2. Recent measurement was invalid:
  - a. Recent measurement (temperature or/and humidity) was:
    - i. valid → pin = high-Z
    - ii. invalid → pin = LOW

The status of each measurement (valid/invalid) can be read out from the status register 2.
  - b. During power up until the start-up measurement and calculation is finished (please refer to Figure 7 in chapter 5.2.)

### NOTICE

If the  $\overline{\text{HI}}$  pin is not used, connect it to GND or use a pull-up resistor to connect it to the  $V_{\text{DD}}$  potential.

## 6 Sensor Communication

### 6.1 Command Overview

Command	Description
0x2C1B	Measurement, single shot, I <sup>2</sup> C clock stretching enabled; Use current resolution
0x241D	Measurement, single shot, I <sup>2</sup> C clock stretching disabled; Use current resolution
0x201E	Measurement, periodic; Use current resolution and interval
0xE000	Fetch periodic measurement data
0xE016	Fetch dew-point value
0x30A2	Soft Reset
0x3093	Break (end periodic measurement)
0x306D	Heater ON
0x3066	Heater OFF
0x3041	Clear Status Register 1
0xF32D	Readout of Status Register 1
0xF352	Readout of Status Register 2
0x7029	Read Identification
0x72A7	Read / Write Sensor Settings (RAM)
0x06	I <sup>2</sup> C Reset at general call address 0x0

Table 11: HTE501 commands

1) Revision 7, 1 October 2021, download from <https://www.nxp.com/webapp/Download?colCode=UM10204&location=null>.  
The document is located behind a login access barrier.

### 6.2 Measured Data Format

Temperature [°C] = (Temperature MSB x 256 + Temperature LSB) /100  
 Humidity [%RH] = (Humidity MSB x 256 + Humidity LSB) /100  
 Dew point temp. [°C] = (Dew point MSB x 256 + Dew point LSB) /100

### 6.3 Measurement Modes

There are two different operation modes to communicate with the sensor:

#### 1. Single Shot Measurement

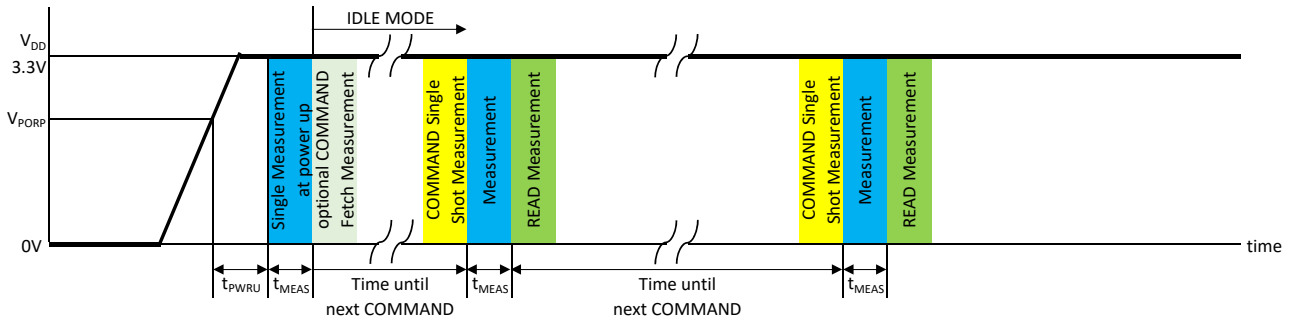

Figure 8: Single shot measurement

#### 2. Periodic Measurement

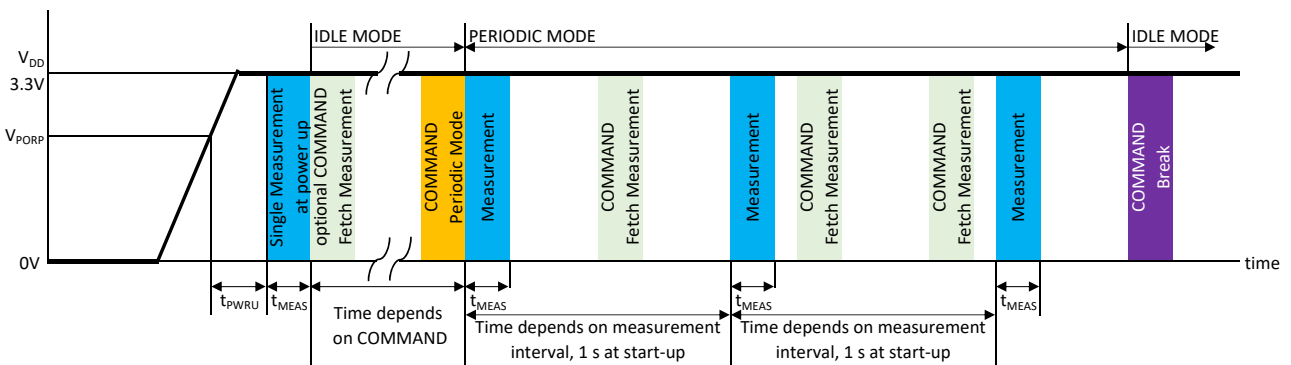

Figure 9: Periodic measurement

### 6.4 Single Shot Measurement (0x2C1B, 0x241D)

The command initiates a single measurement, the measured data is available for query after  $t_{MEAS}$ . I<sup>2</sup>C clock stretching enabled: waiting for the end of the measurement during command execution.

Condition	CMD Hex Code	
	MSB	LSB
I <sup>2</sup> C clock stretching Enabled	2C	1B
I <sup>2</sup> C clock stretching Disabled	24	1D

Table 12: Single shot measurement with or without clock stretching

A single-shot measurement is started after the command has been received successfully. The readout of the calculated values RH and T is started by sending the I<sup>2</sup>C address again in read mode:

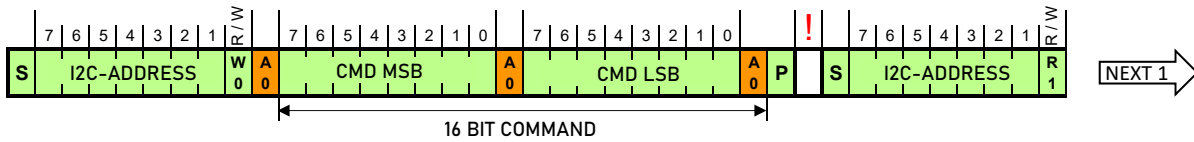

Figure 10: Start single shot measurement readout

In case a command with clock stretching enabled has been issued, the slave holds SCL low until the calculation has been finished:

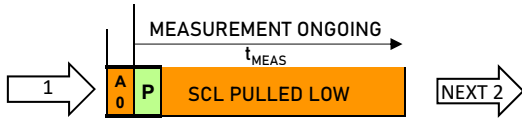

Figure 11: Clock stretching during measurement

In case a command without clock stretching has been issued, the slave does not acknowledge (NACK) a read header as long as the calculation has not been finished:

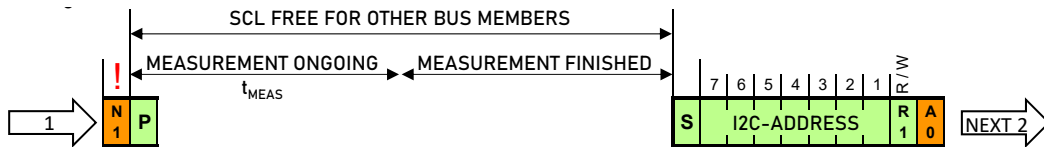

Figure 12: Poll for measuring values until ACK

After the calculation is finished, the slave responds to a read header with a pair of data words, each of them is followed by an 8 bit checksum (CRC8). The first data word contains the temperature value while the second word contains the relative humidity value. The master has to acknowledge each single data byte by an acknowledge (ACK), otherwise the slave will stop sending any further data and wait for a stop condition (P):

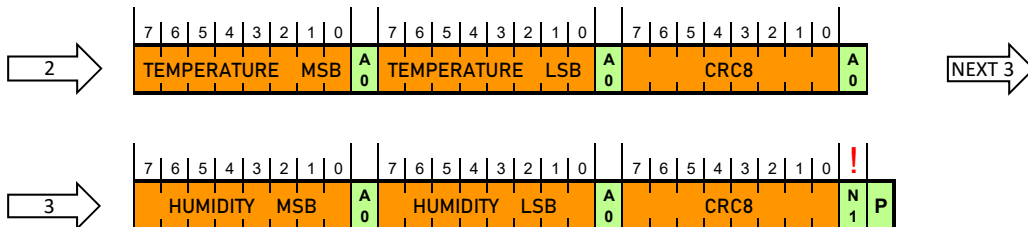

Figure 13: Measured value readout

### 6.5 Periodic Measurement (0x201E)

Once issued, measurements and calculations are started automatically with a given measuring interval and resolution. The standard measurement interval is 1s and the resolution is 13 bit for RH and T. If necessary the measurement frequency and the measurement resolution can be changed (see chapter 6.13).

This mode does not support clock stretching.

Command	CMD Hex Code
Periodic measurement	201E

- Data Bit From Master to Slave
- Data Bit From Slave to Master
- ! = Note the deviation!
- S = Start condition
- P = Stop condition
- R = Read Bit
- W = Write Bit
- A = Acknowledge (SDA low)
- N = Not Acknowledge (SDA high)

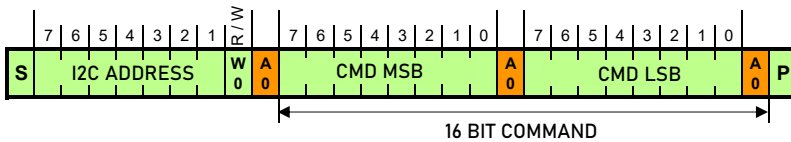

Figure 14: Periodic measurement commands

A periodic measurement command with a different measurement interval/resolution can be issued at any time, but the calculated value will be updated according the new settings earliest after a measurement with the new settings has been performed. Please refer to chapter 6.13.

### 6.6 Fetch Periodic RH&T Measurement Results (0xE000)

Readout of calculation results in periodic measurement mode can be performed using the fetch command. This is similar to the readout of measurement results in single-shot mode, except that clock stretching is always disabled. The slave will answer with NACK if no measurement results are available.

Command	CMD Hex Code
Fetch data	E000

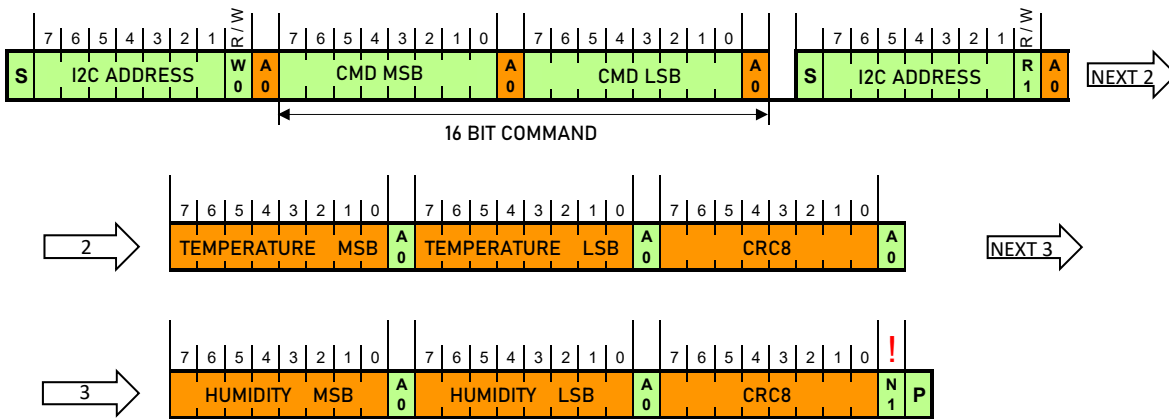

Figure 15: Fetch command

This command is also suitable for reading out the measured data generated by the power-up procedure.

### 6.7 Fetch Td Measurement Results (0xE016)

Readout of latest Td results for can be performed using this command. The slave will answer with NACK in case no measurement results are available.

Command	CMD Hex Code
Fetch data	E016



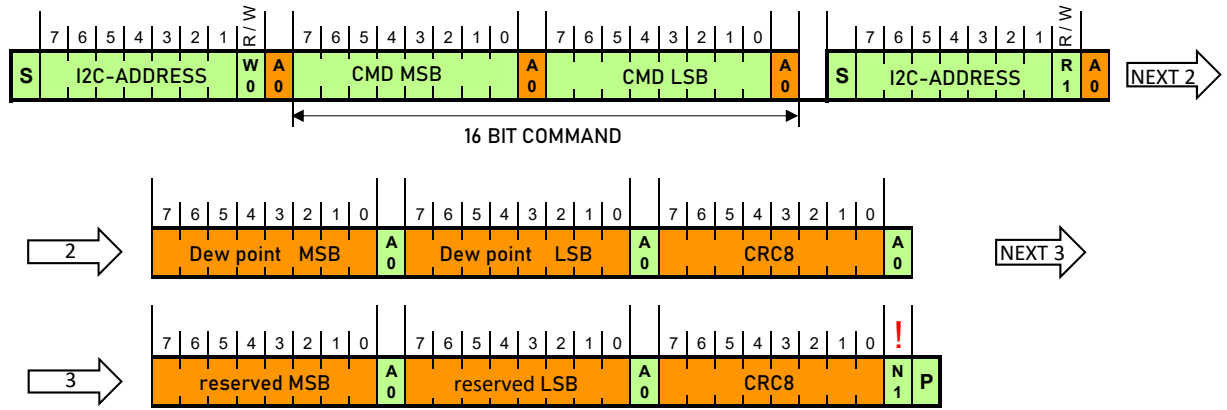

Figure 16: Fetch command

### 6.8 Break Command (0x3093)

The periodic measurement mode can be stopped using the break command. After finishing an ongoing measurement, the sensor will enter the idle mode. An ongoing measurement can delay the transition into the idle mode.

Command	CMD Hex Code
Break	3093

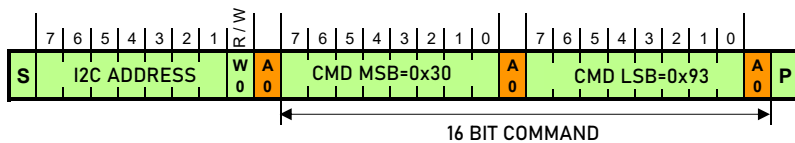

Figure 17: Break command

A single measurement (command) or a reset (command or power-up) both stop the periodic measurement, too.

### 6.9 Reset Commands (0x30A2, 0x06)

The slave supports multiple commands to reset the device. Once a reset command is received, the device is completely reset, like a reset during power-up. During the reset time, the device will not respond to any request on the I<sup>2</sup>C interface. In order to execute the reset on a specific device, the command “Soft Reset” can be used. This forces the system to execute the startup procedure without the need to remove the power supply. The protection will be re-established with the “Soft Reset”.

Command	CMD Hex Code
Soft reset	30A2

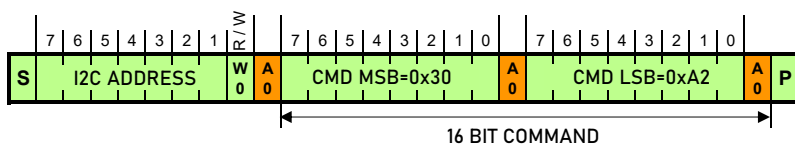

Figure 18: Soft reset

In order to reset all devices on the bus, the master can use the “General call” mode. This generates a reset (system startup) in all devices on the bus which support this function. The effect is the same as for the “Soft Reset” command.

Command	CMD Hex Code
Address byte	00
Second byte	06

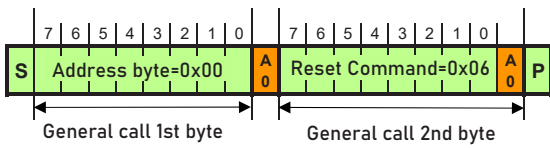

Figure 19: Reset through general call

In order to reset the I<sup>2</sup>C interface only, keep SDA high while toggling SCL nine times or more. This must be followed by a start condition preceding the next command. This sequence does not affect any configuration, status register or system status.

### 6.10 Status Register (0xF32D, 0xF352, 0x3041)

The sensor implements two 16 bit status registers.

Its contents can be read using the following command:

Command	CMD Hex Code	
	MSB	LSB
Read out Status Register 1	0xF3	0x2D
Read out Status Register 2		0x52

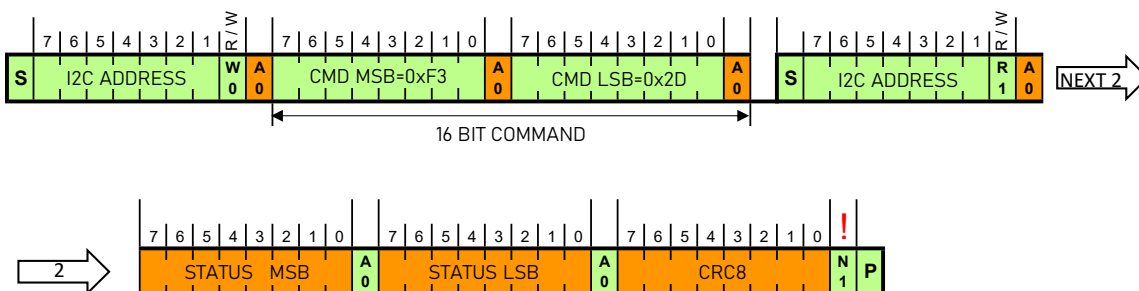

Figure 20: Read out status register

Upon receipt of the following clear command, bits 15, 4 and 3 are cleared in the status register. All other bits remain unaffected:

Command	CMD Hex Code
Clear Status Register	3041

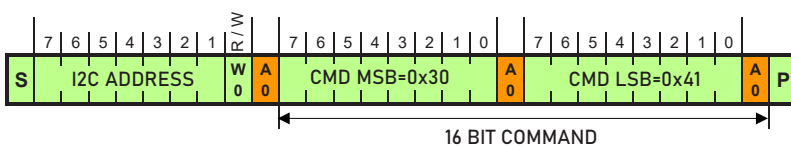

Figure 21: Clear status register 1

#### **i PLEASE NOTE**

The Status Register 2 is read only!

Bit	Name	Description
15	OVERALL_ERROR	0: none of bits [11:0] set 1: at least one of bits [11:0] set This bit is cleared upon the Clear Status Register command
14	Reserved	-
13	CONSTANT_HEATER	0: Heater OFF 1: Heater ON
12	Reserved	-
11	Reserved	-
10	Reserved	-
9	Reserved	-
8	Reserved	-
7	Reserved	-
6	Reserved	-
5	Reserved	-
4	System Reset	0: no reset since status 1 clear 1: POR or I <sup>2</sup> C reset This bit is cleared upon the Clear Status Register command
3	POR	0: no POR since status 1 clear 1: POR occurred This bit is cleared upon the Clear Status Register command
2	Reserved	-
1	Reserved	-
0	CRC	1: checksum of the latest write transfer failed

Table 13: Status register 1

Bit	Name	Description
15	NEW_MEAS	New measurement (T, RH) since last readout available
14	NEW_T_MEAS	New T value since last readout available Cleared upon start of T/RH readout
13	NEW_RH_MEAS	New RH value since last readout available Cleared upon start of T/RH readout
12	NEW_TD_MEAS	New TD value since last readout available Cleared upon start of TD readout
11	Reserved	-
10	PERIODIC_MODE	Status of cyclic measurement 0: only measurements on demand 1: periodic mode active
9	Reserved	-
8	Reserved	-
7	Reserved	-
6	Reserved	-
5	Reserved	-
4	Reserved	-
3	Reserved	-
2	Reserved	-
1	RH_VALID	0: RH measurement faulty 1: RH measurement OK
0	T_VALID	0: T measurement faulty 1: T measurement OK

Table 14: Status register 2

### 6.11 Read Identification (0x7029)

Each sensor device has a specific 8-byte identification. This Identification allows a factory backtracking of each device. When the following command is issued, the I<sup>2</sup>C slave sends all 8 bytes consecutively, followed by a CRC8 checksum (see chapter 6.14 CRC Calculation).

Command	CMD Hex Code
Read Identification	7029

**i PLEASE NOTE**

During the I<sup>2</sup>C communication before the I<sup>2</sup>C address read, a repeated start sequence must be executed, the sequence “stop + start” is not sufficient.

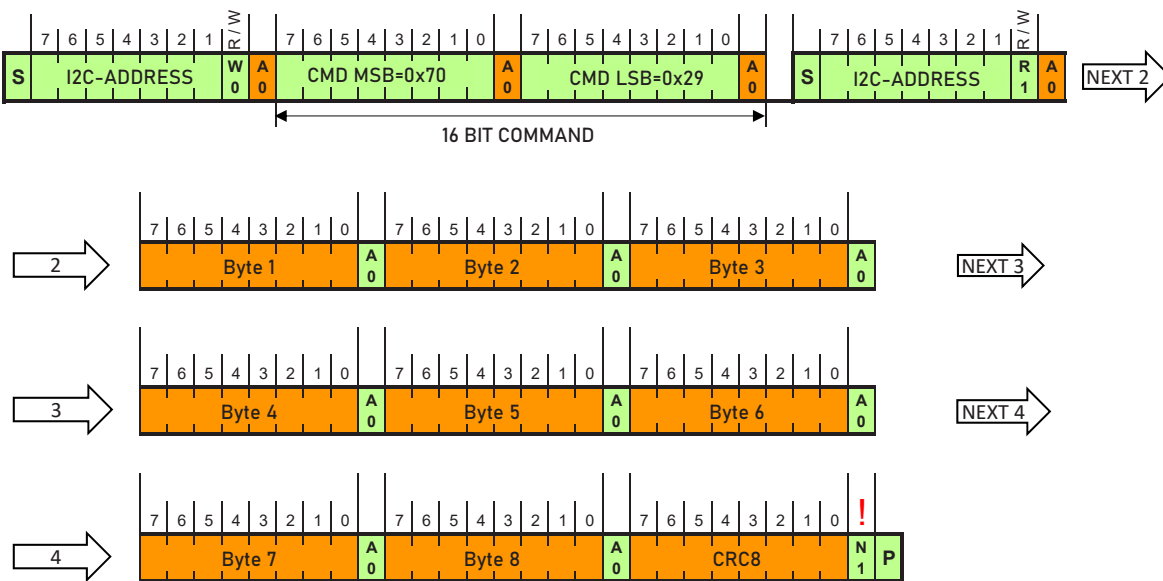

Figure 22: Read Identification

Example:

“1C4606026156553C” (Hexadecimal)

### 6.12 Constant Current Heater (0x306D, 0x3066)

The constant current heater serves various purposes:

- Sensor function test, switching on of heater at constant environmental conditions and adapted time constants for T and RH
  - Temperature T rises
  - Humidity RH falls
  - Dew point TD stays constant
- Faster removal of condensation on the sensor
- Avoid condensation for faster response time at highest humidity
  - Humidity sensor operation at a constant over-temperature of approx. 5° C
  - Dew point temperature readout from heated humidity sensor
  - The actual temperature is measured by a second unheated sensor.
  - The actual humidity is calculated with the help of the dew point temperature of the heated humidity sensor and the temperature of the second unheated sensor.

The advantage of the “constant current heater” is that the power introduced by the heater, and thus also the overtemperature of the sensor, only changes linearly with the supply voltage.

Switching on/off the heater:

Command	CMD Hex Code	
	MSB	LSB
Heater ON	30	0D
Heater OFF		66

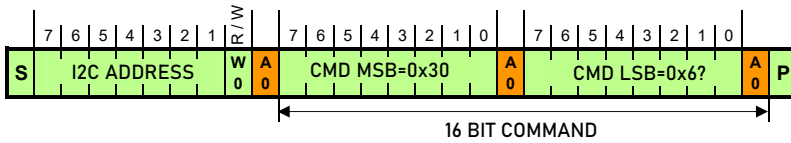

Figure 23: Constant current heater commands

At any kind of reset the heater gets deactivated automatically.

The heater current value is adjustable between 5 mA and 80 mA. The default value for the heater current after power-up is 5 mA.

**NOTICE**

The heater current must not lead to a temperature that exceeds the sensor’s max. upper temperature limit of 135 °C.

To change the heater current, see chapter 6.13.

**6.13 Change Sensor Settings (0x72A7)**

This command allows to change the sensor’s settings. They stay in place until any reset. Sensor settings can only be changed in idle mode.

Command	CMD Hex Code
Change Sensor Settings	72A7

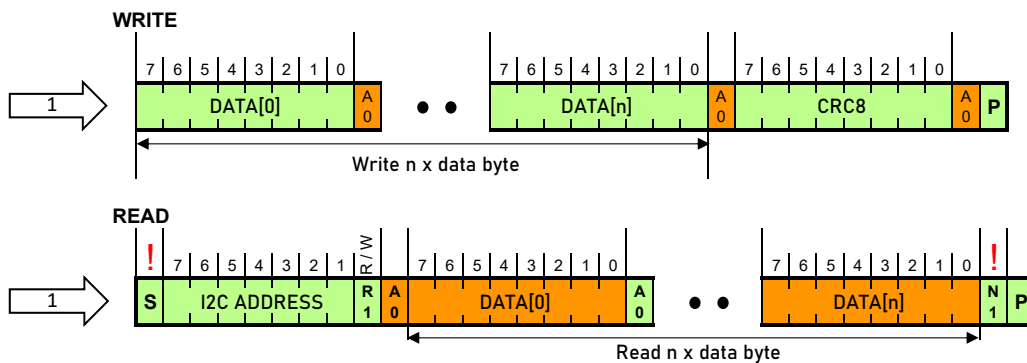
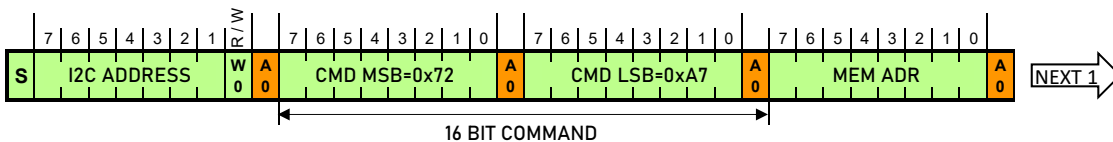

Figure 24: Memory access

Address	Function	Default Value	Description			
			bit	Name	R/W	Description
0x08	Heater settings	0x07 (0000 0111) 5 mA, Heater off	7	Reserved	-	-
			6:3	CURRENT	R/W	Select constant current for heater $I = (CURRENT + 1) * 5 \text{ mA}$ CURRENT = 0...15, I = 5...80 mA
			2:0	Constant Current Heater	R/W	111 = HEATER OFF 110 = HEATER ON other = do not use
0x0F	Measurement resolution	0x2D (0010 1101) T = 13 bit RH = 13 bit	7:6	Reserved	-	-
			5:3	RH_RES	R/W	Measurement resolution: 000: 8 bit 001: 9 bit 010: 10 bit 011: 11 bit 100: 12 bit 101: 13 bit Others: 14 bit
			2:0	T_RES	R/W	
0x10 0x11	Measurement interval in periodic mode	0x0014 1 second	15:0	RM_CYCLE	R/W	Measurement cycle in run- mode. Unit of an LSB is 1/20 s (50 ms), RM_CYCLE ranges from 0 (start immediately after calculation is done) to 0xffff * 0.05 s = 54 m 36.75 s

Table 15: Sensor settings registers

Detailed example for HEATER ON:

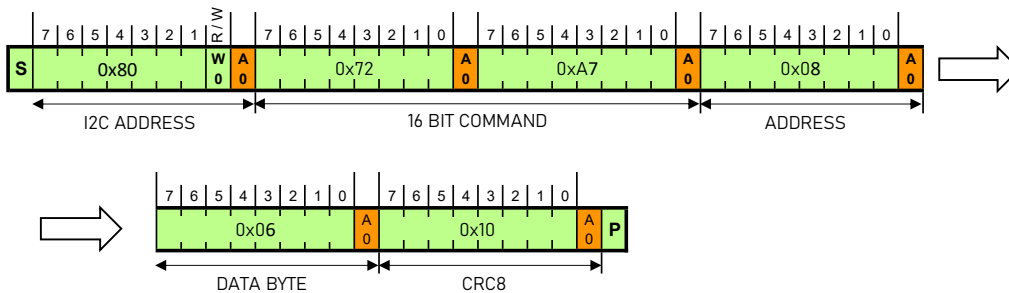

Figure 25: Sensor settings example: HEATER ON

Measurement interval in periodic mode:

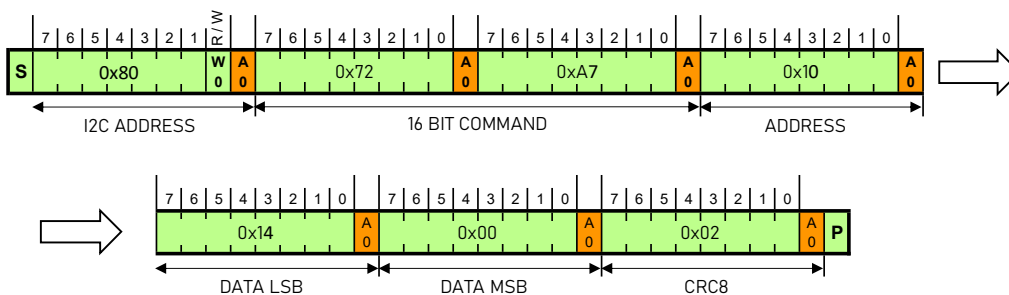

Figure 26: Sensor settings example: set measurement interval (back) to 1 second

**i PLEASE NOTE**

A short measurement interval can influence the power consumption and therefore the self-heating of the sensor.

**i PLEASE NOTE**

The CRC8 calculation includes all bytes following the command bytes.

### 6.14 CRC Calculation

Response data words/memory write data are protected by a CRC8 checksum:

Property	Value
Name	CRC8
Width	8 bit
Polynomial	0x31 (x8 + x5 + x4 + 1)
XOR input	0xFF
Reflect input	False
Reflect output	False
XOR output	0x00

Table 16: CRC checksum calculation

### 6.15 Package / Dimensions

The HTE501 sensor is provided as an open-cavity DFN (= Dual Flat No Leads) package. The humidity sensor opening is centered on the top side of the package.

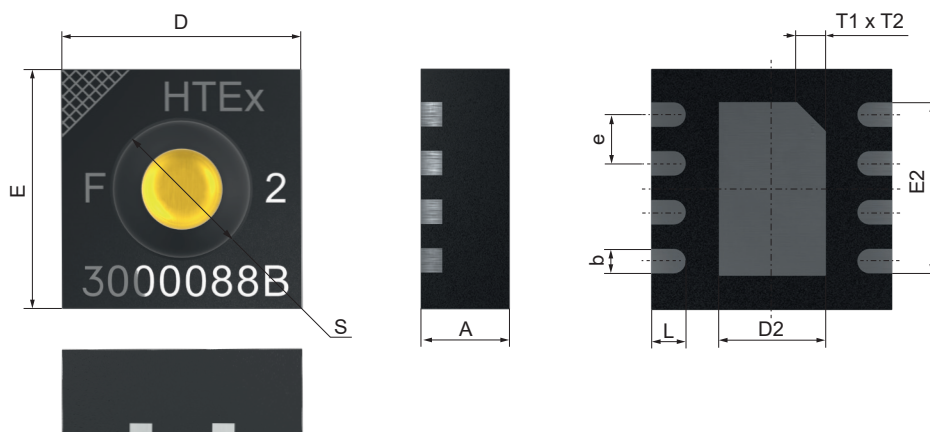

Figure 27: Package layout

PARAMETER	SYMBOL	MIN.	NOM.	MAX.	UNIT	COMMENT
Package width	D	2.40	2.50	2.60	mm	
Package length	E	2.40	2.50	2.60	mm	
Package height	A	0.80	0.90	1.00	mm	
Cavity diameter	S		1.30		mm	On top of package
Leadframe height	A3		0.20		mm	Not shown in the drawing
Pad pitch	e		0.50		mm	
Pad width	b	0.20	0.25	0.30	mm	
Pad length	L	0.30	0.35	0.40	mm	
Thermal pad length	D2	1.00	1.10	1.20	mm	
Thermal pad width	E2	1.70	1.80	1.90	mm	
Thermal pad marking	T1xT2		0.30x0.30		mm	Indicates pin 1

Table 17: Package dimensions

### 6.16 Tape and Reel Packaging

The HTE501 has a Moisture Sensitivity Level (MSL) of 1, according to IPC/JEDEC J-STD-020. At the same time, it is recommended to further process the sensors within 1 year after date of delivery.

Dimensions T&R in mm:

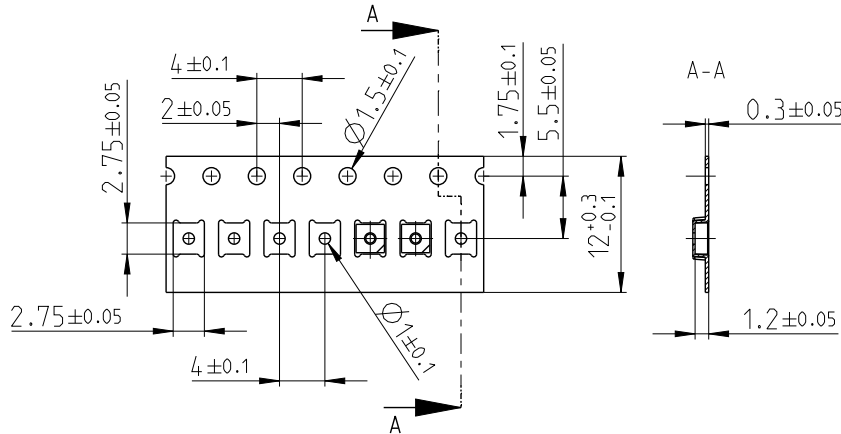

Figure 28: Tape layout

Reel size 330.2 mm (13"), Leader 520 mm (20.5"), Trailer 1240 mm (48.8").

Orientation on the tape:

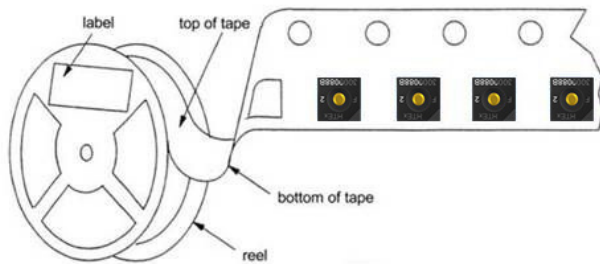

Figure 29: Orientation on the tape

### 6.17 Traceability

There are two possibilities for identification / traceability:

1. Read identification command (0x7029):  
serial number of each individual sensor (see description of command 0x7029)
2. Laser marking:



A triangular mark at the top left indicates pin 1.

The upper line represents the designation of the component and consists of up to 6 characters. The "x" is a placeholder for the exact type, e.g. 501.

The remaining characters are a tracking code and are used by the manufacturer for identification.

Figure 30: HTE501 laser marking



### 6.18 Ordering Information

Feature	Description	Code
		<b>HTE501-</b>
Tape and reel packaging	2500 pcs. per reel	<b>TR2,5</b>

Ordering example: **HTE501-TR2,5**

Feature	Code	Description
Model	<b>HTE501</b>	Digital Humidity and Temperature Sensor
Tape and reel packaging	<b>TR2,5</b>	2500 pcs. per reel

### 6.19 Recommended Layout

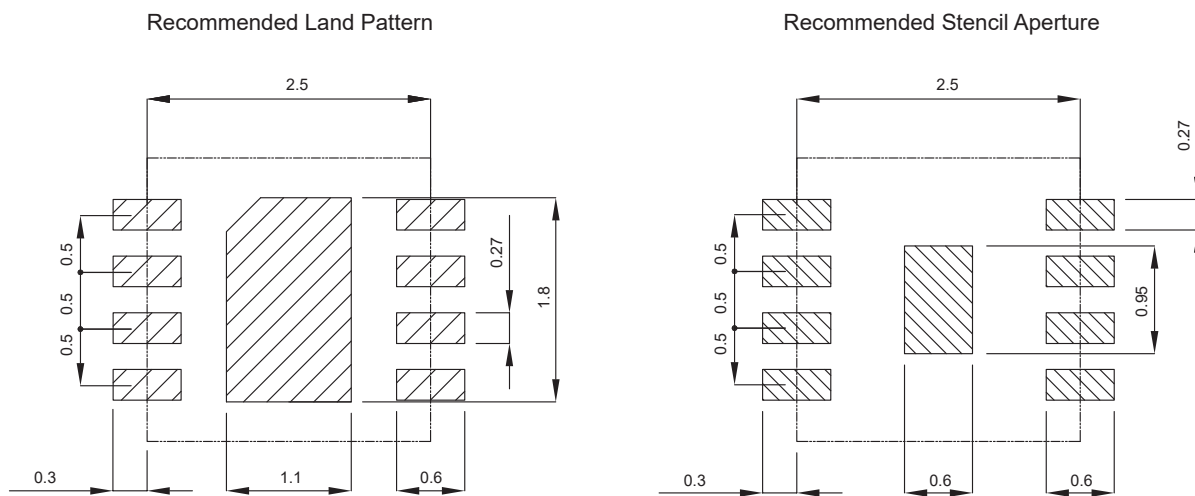

Figure 31: Recommended land pattern and stencil aperture

## 7 Quality

The HTE501 is qualified for automotive applications according to AEC Q100 grade 1 with an extended operating temperature range of +135 °C. In addition, the HTE501 is qualified for industrial and commercial operating environments according to JEDEC JESD47.

## 8 Additional Documentation

Document	Description	Link
HTE501 Handling Instructions	HTE501	<a href="http://www.epluse.com/hte501">www.epluse.com/hte501</a>
HTE501 CRC8 Code Example	Code samples for Arduino and Raspberry PI	<a href="https://github.com/Epluse">https://github.com/Epluse</a>

Table 18: Applicable documentation

## 9 Revision History

Date	Version	Page(s)	Changes
September 2021	1.0	1-26	Initial release
December 2021	1.1	1-26	General enhancements
January 2022	1.2	1-25	General enhancements
February 2022	1.3	1-26	Editorial changes
May 2022	1.4	1-25	Editorial changes
August 2022	1.5	1-27	Editorial changes
December 2022	1.6	1-27	Chapter 2, Fig. 2, Typical application schematic: $V_{SS}$ and $V_{DD}$ were mixed up Accuracy indication enhanced Chapter 6.16, Fig. 27, Tape layout: ASIC orientation corrected on the tape Link to NXP's UM10204 updated and hint added
June 2023	1.7	1-27	New Layout Typical Applications: Automotive Industry added and reference to automotive standards in chapter 7 Table 3: Footnote hint on Sensor Specification Accuracy Figure 5: Normal operating area extended to negative temperatures Chapter 6.13, change sensor settings examples and CRC8 calculation hint. Chapter 7: Hint on Automotive Standard AEC Q100 added.

Table 19: Revision history

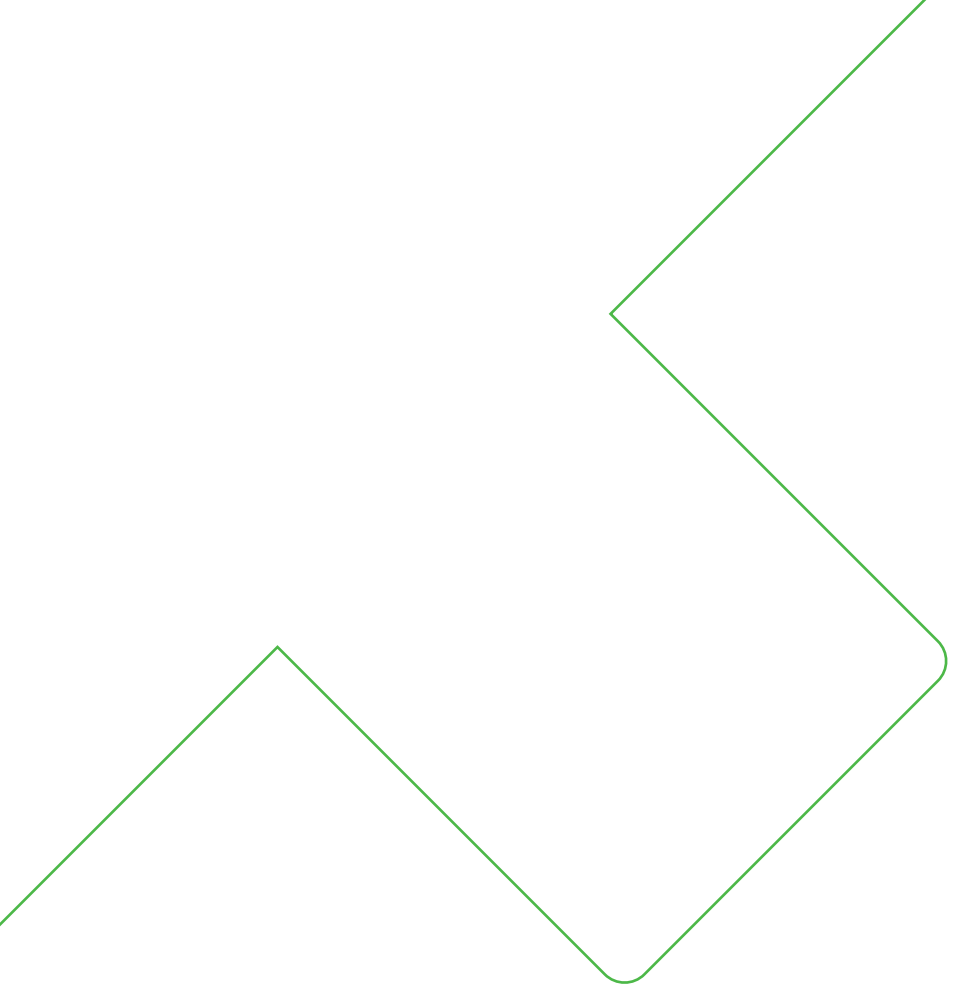

Company Headquarters &  
Production Site

**E+E Elektronik Ges.m.b.H.**  
Langwiesen 7  
4209 Engerwitzdorf | Austria  
T +43 7235 605-0  
F +43 7235 605-8  
info@epluse.com  
www.epluse.com

Subsidiaries

**E+E Sensor Technology (Shanghai) Co., Ltd.**  
T +86 21 6117 6129  
info@epluse.cn

**E+E Elektronik France SARL**  
T +33 4 74 72 35 82  
info.fr@epluse.com

**E+E Elektronik Deutschland GmbH**  
T +49 6171 69411-0  
info.de@epluse.com

**E+E Elektronik India Private Limited**  
T +91 990 440 5400  
info.in@epluse.com

**E+E Elektronik Italia S.R.L.**  
T +39 02 2707 86 36  
info.it@epluse.com

**E+E Elektronik Korea Ltd.**  
T +82 31 732 6050  
info.kr@epluse.com

**E+E Elektronik Corporation**  
T +1 847 490 0520  
info.us@epluse.com

Version v1.7 | 06-2023  
Modification rights reserved



—  
your partner  
in sensor  
technology.

[www.epluse.com](http://www.epluse.com)